

CHAPTER – 31 CAPACITOR

1. Given that

$$\text{Number of electron} = 1 \times 10^{12}$$

$$\text{Net charge } Q = 1 \times 10^{12} \times 1.6 \times 10^{-19} = 1.6 \times 10^{-7} \text{ C}$$

∴ The net potential difference = 10 V.

$$\therefore \text{Capacitance} - C = \frac{q}{v} = \frac{1.6 \times 10^{-7}}{10} = 1.6 \times 10^{-8} \text{ F.}$$

2. $A = \pi r^2 = 25 \pi \text{ cm}^2$

$$d = 0.1 \text{ cm}$$

$$C = \frac{\epsilon_0 A}{d} = \frac{8.854 \times 10^{-12} \times 25 \times 3.14}{0.1} = 6.95 \times 10^{-5} \mu\text{F.}$$

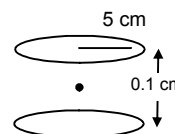

3. Let the radius of the disc = R

$$\therefore \text{Area} = \pi R^2$$

$$C = 1 \text{ f}$$

$$D = 1 \text{ mm} = 10^{-3} \text{ m}$$

$$\therefore C = \frac{\epsilon_0 A}{d}$$

$$\Rightarrow 1 = \frac{8.85 \times 10^{-12} \times \pi r^2}{10^{-3}} \Rightarrow r^2 = \frac{10^{-3} \times 10^{12}}{8.85 \times \pi} = \frac{10^9}{27.784} = 5998.5 \text{ m} = 6 \text{ Km}$$

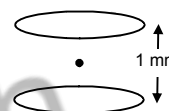

4. $A = 25 \text{ cm}^2 = 2.5 \times 10^{-3} \text{ cm}^2$

$$d = 1 \text{ mm} = 0.01 \text{ m}$$

$$V = 6 \text{ V} \quad Q = ?$$

$$C = \frac{\epsilon_0 A}{d} = \frac{8.854 \times 10^{-12} \times 2.5 \times 10^{-3}}{0.01}$$

$$Q = CV = \frac{8.854 \times 10^{-12} \times 2.5 \times 10^{-3}}{0.01} \times 6 = 1.32810 \times 10^{-10} \text{ C}$$

$$W = Q \times V = 1.32810 \times 10^{-10} \times 6 = 8 \times 10^{-10} \text{ J.}$$

5. Plate area $A = 25 \text{ cm}^2 = 2.5 \times 10^{-3} \text{ m}^2$

$$\text{Separation } d = 2 \text{ mm} = 2 \times 10^{-3} \text{ m}$$

$$\text{Potential } v = 12 \text{ v}$$

$$(a) \text{ We know } C = \frac{\epsilon_0 A}{d} = \frac{8.85 \times 10^{-12} \times 2.5 \times 10^{-3}}{2 \times 10^{-3}} = 11.06 \times 10^{-12} \text{ F}$$

$$C = \frac{q}{v} \Rightarrow 11.06 \times 10^{-12} = \frac{q}{12}$$

$$\Rightarrow q_1 = 1.32 \times 10^{-10} \text{ C.}$$

(b) Then d = decreased to 1 mm

$$\therefore d = 1 \text{ mm} = 1 \times 10^{-3} \text{ m}$$

$$C = \frac{\epsilon_0 A}{d} = \frac{q}{v} = \frac{8.85 \times 10^{-12} \times 2.5 \times 10^{-3}}{1 \times 10^{-3}} = \frac{2}{12}$$

$$\Rightarrow q_2 = 8.85 \times 2.5 \times 12 \times 10^{-12} = 2.65 \times 10^{-10} \text{ C.}$$

$$\therefore \text{The extra charge given to plate} = (2.65 - 1.32) \times 10^{-10} = 1.33 \times 10^{-10} \text{ C.}$$

6. $C_1 = 2 \mu\text{F}, \quad C_2 = 4 \mu\text{F},$

$$C_3 = 6 \mu\text{F} \quad V = 12 \text{ V}$$

$$Cq = C_1 + C_2 + C_3 = 2 + 4 + 6 = 12 \mu\text{F} = 12 \times 10^{-6} \text{ F}$$

$$q_1 = 12 \times 2 = 24 \mu\text{C}, \quad q_2 = 12 \times 4 = 48 \mu\text{C}, \quad q_3 = 12 \times 6 = 72 \mu\text{C}$$

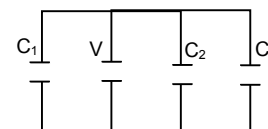
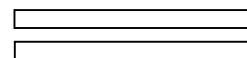

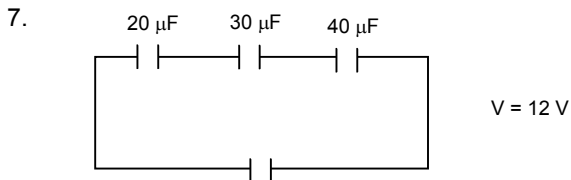

∴ The equivalent capacity.

$$C = \frac{C_1 C_2 C_3}{C_2 C_3 + C_1 C_3 + C_1 C_2} = \frac{20 \times 30 \times 40}{30 \times 40 + 20 \times 40 + 20 \times 30} = \frac{24000}{2600} = 9.23 \mu\text{F}$$

(a) Let Equivalent charge at the capacitor = q

$$C = \frac{q}{V} \Rightarrow q = C \times V = 9.23 \times 12 = 110 \mu\text{C on each.}$$

As this is a series combination, the charge on each capacitor is same as the equivalent charge which is $110 \mu\text{C}$.

(b) Let the work done by the battery = W

$$\therefore V = \frac{W}{q} \Rightarrow W = Vq = 110 \times 12 \times 10^{-6} = 1.33 \times 10^{-3} \text{ J.}$$

8. $C_1 = 8 \mu\text{F}$, $C_2 = 4 \mu\text{F}$, $C_3 = 4 \mu\text{F}$

$$C_{eq} = \frac{(C_2 + C_3) \times C_1}{C_1 + C_2 + C_3}$$

$$= \frac{8 \times 8}{16} = 4 \mu\text{F}$$

Since B & C are parallel & are in series with A

So, $q_1 = 8 \times 6 = 48 \mu\text{C}$

$q_2 = 4 \times 6 = 24 \mu\text{C}$

$q_3 = 4 \times 6 = 24 \mu\text{C}$

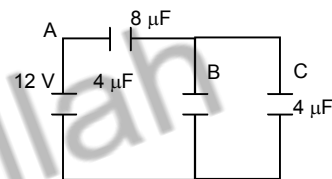

9. (a)

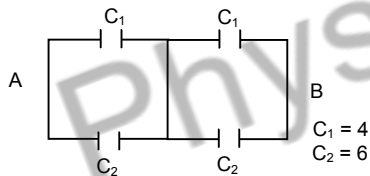

∴ C_1, C_1 are series & C_2, C_2 are series as the V is same at p & q . So no current pass through p & q .

$$\frac{1}{C} = \frac{1}{C_1} = \frac{1}{C_2} \Rightarrow \frac{1}{C} = \frac{1+1}{C_1 C_2}$$

$$C_p = \frac{C_1}{2} = \frac{4}{2} = 2 \mu\text{F}$$

$$\text{And } C_q = \frac{C_2}{2} = \frac{6}{2} = 3 \mu\text{F}$$

$$\therefore C = C_p + C_q = 2 + 3 = 5 \mu\text{F}$$

(b) $C_1 = 4 \mu\text{F}$, $C_2 = 6 \mu\text{F}$,

In case of p & q , $q = 0$

$$\therefore C_p = \frac{C_1}{2} = \frac{4}{2} = 2 \mu\text{F}$$

$$C_q = \frac{C_2}{2} = \frac{6}{2} = 3 \mu\text{F}$$

& $C' = 2 + 3 = 5 \mu\text{F}$

C & $C' = 5 \mu\text{F}$

∴ The equation of capacitor $C = C' + C'' = 5 + 5 = 10 \mu\text{F}$

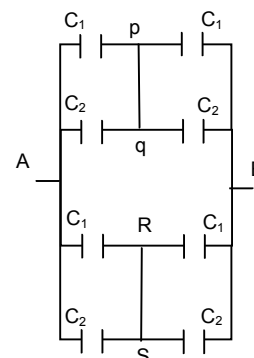

10. $V = 10 \text{ v}$
 $C_{eq} = C_1 + C_2$ [\therefore They are parallel]
 $= 5 + 6 = 11 \mu\text{F}$
 $q = CV = 11 \times 10 = 110 \mu\text{C}$

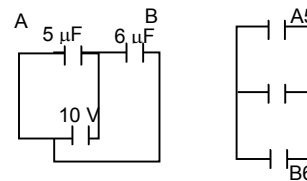

11. The capacitance of the outer sphere = $2.2 \mu\text{F}$
 $C = 2.2 \mu\text{F}$
 Potential, $V = 10 \text{ v}$
 Let the charge given to individual cylinder = q .

$$C = \frac{q}{V}$$

$$\Rightarrow q = CV = 2.2 \times 10 = 22 \mu\text{C}$$

\therefore The total charge given to the inner cylinder = $22 + 22 = 44 \mu\text{C}$

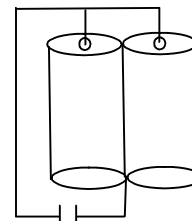

12. $C = \frac{q}{V}$, Now $V = \frac{Kq}{R}$

$$\text{So, } C_1 = \frac{q}{(Kq/R_1)} = \frac{R_1}{K} = 4 \pi \epsilon_0 R_1$$

Similarly $C_2 = 4 \pi \epsilon_0 R_2$

The combination is necessarily parallel.

Hence $C_{eq} = 4 \pi \epsilon_0 R_1 + 4 \pi \epsilon_0 R_2 = 4 \pi \epsilon_0 (R_1 + R_2)$

- 13.

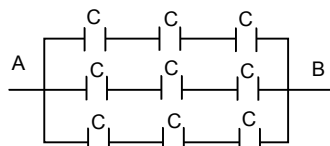

$$\therefore C = 2 \mu\text{F}$$

\therefore In this system the capacitance are arranged in series. Then the capacitance is parallel to each other.

(a) \therefore The equation of capacitance in one row

$$C = \frac{C}{3}$$

(b) and three capacitance of capacity $\frac{C}{3}$ are connected in parallel

\therefore The equation of capacitance

$$C = \frac{C}{3} + \frac{C}{3} + \frac{C}{3} = C = 2 \mu\text{F}$$

As the volt capacitance on each row are same and the individual is

$$= \frac{\text{Total}}{\text{No. of capacitance}} = \frac{60}{3} = 20 \text{ V}$$

14. Let there are 'x' no of capacitors in series ie in a row

$$\text{So, } x \times 50 = 200$$

$$\Rightarrow x = 4 \text{ capacitors.}$$

$$\text{Effective capacitance in a row} = \frac{10}{4}$$

Now, let there are 'y' such rows,

$$\text{So, } \frac{10}{4} \times y = 10$$

$$\Rightarrow y = 4 \text{ capacitor.}$$

So, the combinations of four rows each of 4 capacitors.

15.

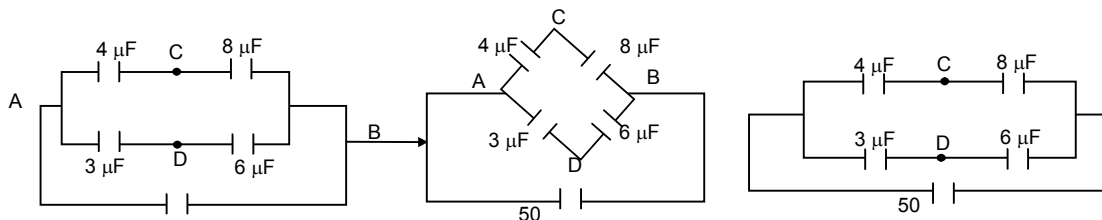

(a) Capacitor = $\frac{4 \times 8}{4 + 8} = \frac{8}{3} \mu$

and $\frac{6 \times 3}{6 + 3} = 2 \mu F$

(i) The charge on the capacitance $\frac{8}{3} \mu F$

$\therefore Q = \frac{8}{3} \times 50 = \frac{400}{3}$

\therefore The potential at $4 \mu F = \frac{400}{3 \times 4} = \frac{100}{3}$

at $8 \mu F = \frac{400}{3 \times 8} = \frac{100}{6}$

The Potential difference = $\frac{100}{3} - \frac{100}{6} = \frac{50}{3} \mu V$

(ii) Hence the effective charge at $2 \mu F = 50 \times 2 = 100 \mu F$

\therefore Potential at $3 \mu F = \frac{100}{3}$; Potential at $6 \mu F = \frac{100}{6}$

\therefore Difference = $\frac{100}{3} - \frac{100}{6} = \frac{50}{3} \mu V$

\therefore The potential at C & D is $\frac{50}{3} \mu V$

(b) $\therefore \frac{P}{q} = \frac{R}{S} = \frac{1}{2} = \frac{1}{2}$ = It is balanced. So from it is cleared that the wheat star bridge balanced. So

the potential at the point C & D are same. So no current flow through the point C & D. So if we connect another capacitor at the point C & D the charge on the capacitor is zero.

16. Ceq between a & b

= $\frac{C_1 C_2}{C_1 + C_2} + C_3 + \frac{C_1 C_2}{C_1 + C_2}$

= $C_3 + \frac{2C_1 C_2}{C_1 + C_2}$ (\therefore The three are parallel)

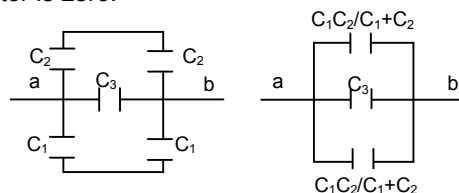

17. In the figure the three capacitors are arranged in parallel.

All have same surface area = $a = \frac{A}{3}$

First capacitance $C_1 = \frac{\epsilon_0 A}{3d}$

2nd capacitance $C_2 = \frac{\epsilon_0 A}{3(b+d)}$

3rd capacitance $C_3 = \frac{\epsilon_0 A}{3(2b+d)}$

Ceq = $C_1 + C_2 + C_3$

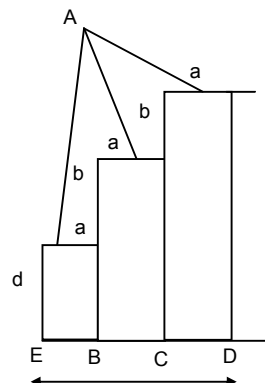

$$= \frac{\epsilon_0 A}{3d} + \frac{\epsilon_0 A}{3(b+d)} + \frac{\epsilon_0 A}{3(2b+d)} = \frac{\epsilon_0 A}{3} \left(\frac{1}{d} + \frac{1}{b+d} + \frac{1}{2b+d} \right)$$

$$= \frac{\epsilon_0 A}{3} \left(\frac{(b+d)(2b+d) + (2b+d)d + (b+d)d}{d(b+d)(2b+d)} \right)$$

$$= \frac{\epsilon_0 A(3d^2 + 6bd + 2b^2)}{3d(b+d)(2b+d)}$$

18. (a) $C = \frac{2\epsilon_0 L}{\ln(R_2/R_1)} = \frac{e \times 3.14 \times 8.85 \times 10^{-2} \times 10^{-1}}{\ln 2}$ [ln2 = 0.6932]

= $80.17 \times 10^{-13} \Rightarrow 8 \text{ PF}$

(b) Same as R_2/R_1 will be same.

19. Given that

$C = 100 \text{ PF} = 100 \times 10^{-12} \text{ F}$

$C_{c2} = 20 \text{ PF} = 20 \times 10^{-12} \text{ F}$

$V = 24 \text{ V}$

$q = 24 \times 100 \times 10^{-12} = 24 \times 10^{-10}$

$q_2 = ?$

Let $q_1 =$ The new charge 100 PF $V_1 =$ The Voltage.

Let the new potential is V_1

After the flow of charge, potential is same in the two capacitor

$$V_1 = \frac{q_2}{C_2} = \frac{q_1}{C_1}$$

$$= \frac{q - q_1}{C_2} = \frac{q_1}{C_1}$$

$$= \frac{24 \times 10^{-10} - q_1}{24 \times 10^{-12}} = \frac{q_1}{100 \times 10^{-12}}$$

$$= 24 \times 10^{-10} - q_1 = \frac{q_1}{5}$$

$$= 6q_1 = 120 \times 10^{-10}$$

$$= q_1 = \frac{120}{6} \times 10^{-10} = 20 \times 10^{-10}$$

$$\therefore V_1 = \frac{q_1}{C_1} = \frac{20 \times 10^{-10}}{100 \times 10^{-12}} = 20 \text{ V}$$

20.

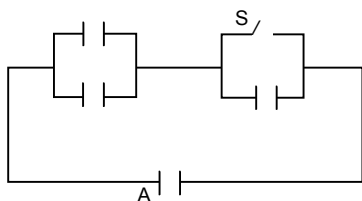

Initially when 's' is not connected,

$$C_{\text{eff}} = \frac{2C}{3} q = \frac{2C}{3} \times 50 = \frac{5}{2} \times 10^{-4} = 1.66 \times 10^{-4} \text{ C}$$

After the switch is made on,

Then $C_{\text{eff}} = 2C = 10^{-5}$

$Q = 10^{-5} \times 50 = 5 \times 10^{-4}$

Now, the initial charge will remain stored in the stored in the short capacitor

Hence net charge flowing

$$= 5 \times 10^{-4} - 1.66 \times 10^{-4} = 3.3 \times 10^{-4} \text{ C.}$$

21.

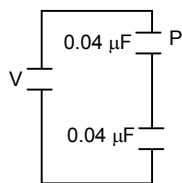

Given that mass of particle $m = 10 \text{ mg}$

Charge $1 = -0.01 \text{ } \mu\text{C}$

$A = 100 \text{ cm}^2$ Let potential = V

The Equation capacitance $C = \frac{0.04}{2} = 0.02 \text{ } \mu\text{F}$

The particle may be in equilibrium, so that the wt. of the particle acting down ward, must be balanced by the electric force acting up ward.

$$\therefore qE = Mg$$

Electric force = $qE = q \frac{V}{d}$ where V – Potential, d – separation of both the plates.

$$= q \frac{VC}{\epsilon_0 A} \quad C = \frac{\epsilon_0 A}{d} \quad d = \frac{\epsilon_0 A}{C}$$

$$qE = mg$$

$$= \frac{QVC}{\epsilon_0 A} = mg$$

$$= \frac{0.01 \times 0.02 \times V}{8.85 \times 10^{-12} \times 100} = 0.1 \times 980$$

$$\Rightarrow V = \frac{0.1 \times 980 \times 8.85 \times 10^{-10}}{0.0002} = 0.00043 = 43 \text{ MV}$$

22. Let mass of electron = μ

Charge electron = e

We know, 'q'

For a charged particle to be projected in side to plates of a parallel plate capacitor with electric field E ,

$$y = \frac{1qE}{2m} \left(\frac{x}{\mu} \right)^2$$

where y – Vertical distance covered or

x – Horizontal distance covered

μ – Initial velocity

From the given data,

$$y = \frac{d_1}{2}, \quad E = \frac{V}{R} = \frac{qd_1}{\epsilon_0 a^2 \times d_1} = \frac{q}{\epsilon_0 a^2}, \quad x = a, \quad \mu = ?$$

For capacitor A –

$$V_1 = \frac{q}{C_1} = \frac{qd_1}{\epsilon_0 a^2} \text{ as } C_1 = \frac{\epsilon_0 a^2}{d_1}$$

Here q = chare on capacitor.

$$q = C \times V \text{ where } C = \text{Equivalent capacitance of the total arrangement} = \frac{\epsilon_0 a^2}{d_1 + d_2}$$

$$\text{So, } q = \frac{\epsilon_0 a^2}{d_1 + d_2} \times V$$

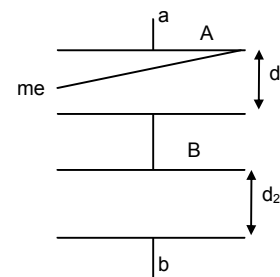

Hence $E = \frac{q}{\epsilon_0 a^2} = \frac{\epsilon_0 a^2 \times V}{(d_1 + d_2)\epsilon_0 a^2} = \frac{V}{(d_1 + d_2)}$

Substituting the data in the known equation, we get, $\frac{d_1}{2} = \frac{1}{2} \times \frac{e \times V}{(d_1 + d_2)m} \times \frac{a^2}{u^2}$

$\Rightarrow u^2 = \frac{Vea^2}{d_1 m (d_1 + d_2)} \Rightarrow u = \left(\frac{Vea^2}{d_1 m (d_1 + d_2)} \right)^{1/2}$

23. The acceleration of electron $a_e = \frac{q_e m_e}{M_e}$

The acceleration of proton = $\frac{q_p e}{M_p} = a_p$

The distance travelled by proton $X = \frac{1}{2} a_p t^2$... (1)

The distance travelled by electron ... (2)

From (1) and (2) $\Rightarrow 2 - X = \frac{1}{2} a_c t^2$ $x = \frac{1}{2} a_c t^2$

$\Rightarrow \frac{x}{2-x} = \frac{a_p}{a_c} = \frac{\left(\frac{q_p E}{M_p} \right)}{\left(\frac{q_c F}{M_c} \right)}$

$= \frac{x}{2-x} = \frac{M_c}{M_p} = \frac{9.1 \times 10^{-31}}{1.67 \times 10^{-27}} = \frac{9.1}{1.67} \times 10^{-4} = 5.449 \times 10^{-4}$

$\Rightarrow x = 10.898 \times 10^{-4} - 5.449 \times 10^{-4} x$

$\Rightarrow x = \frac{10.898 \times 10^{-4}}{1.0005449} = 0.001089226$

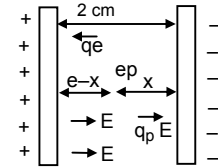

24. (a)

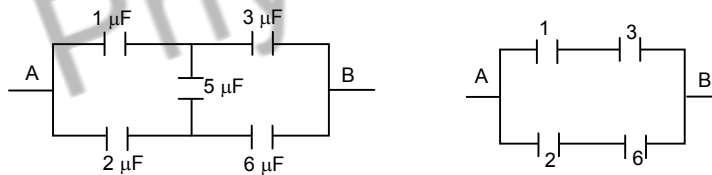

As the bridge is balanced there is no current through the 5 μF capacitor
So, it reduces to

similar in the case of (b) & (c)
as 'b' can also be written as.

$C_{eq} = \frac{1 \times 3}{1+3} + \frac{2 \times 6}{2+6} = \frac{3}{4} + \frac{12}{8} = \frac{6+12}{8} = 2.25 \mu F$

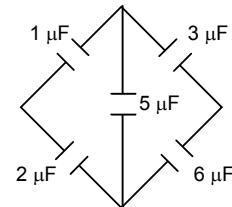

25. (a) By loop method application in the closed circuit ABCabDA

$-12 + \frac{2Q}{2\mu F} + \frac{Q_1}{2\mu F} + \frac{Q_1}{4\mu F} = 0$... (1)

In the close circuit ABCDA

$-12 + \frac{Q}{2\mu F} + \frac{Q+Q_1}{4\mu F} = 0$... (2)

From (1) and (2) $2Q + 3Q_1 = 48$... (3)

And $3Q - Q_1 = 48$ and subtracting $Q = 4Q_1$, and substitution in equation

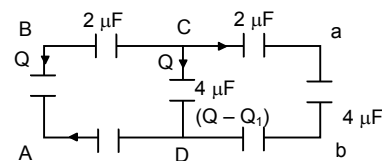

$$2Q + 3Q_1 = 48 \Rightarrow 8Q_1 + 3Q_1 = 48 \Rightarrow 11Q_1 = 48, q_1 = \frac{48}{11}$$

$$V_{ab} = \frac{Q_1}{4\mu F} = \frac{48}{11 \times 4} = \frac{12}{11} \text{ V}$$

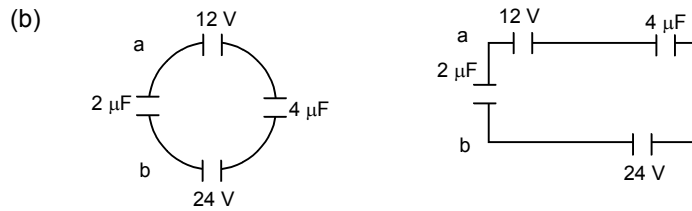

The potential = $24 - 12 = 12$

$$\text{Potential difference } V = \frac{(2 \times 0 + 12 \times 4)}{2 + 4} = \frac{48}{6} = 8 \text{ V}$$

\therefore The $V_a - V_b = -8 \text{ V}$

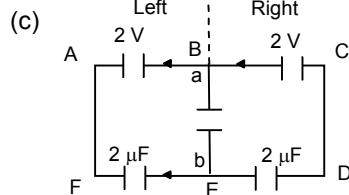

From the figure it is cleared that the left and right branch are symmetry and reversed, so the current go towards BE from BAFEB same as the current from EDCBE.

$$\therefore \text{The net charge } Q = 0 \quad \therefore V = \frac{Q}{C} = \frac{0}{C} = 0 \quad \therefore V_{ab} = 0$$

\therefore The potential at K is zero.

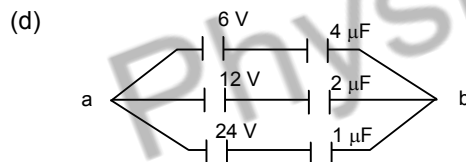

$$\text{The net potential} = \frac{\text{Net charge}}{\text{Net capacitance}} = \frac{24 + 24 + 24}{7} = \frac{72}{7} \approx 10.3 \text{ V}$$

$\therefore V_a - V_b = -10.3 \text{ V}$

26. (a)

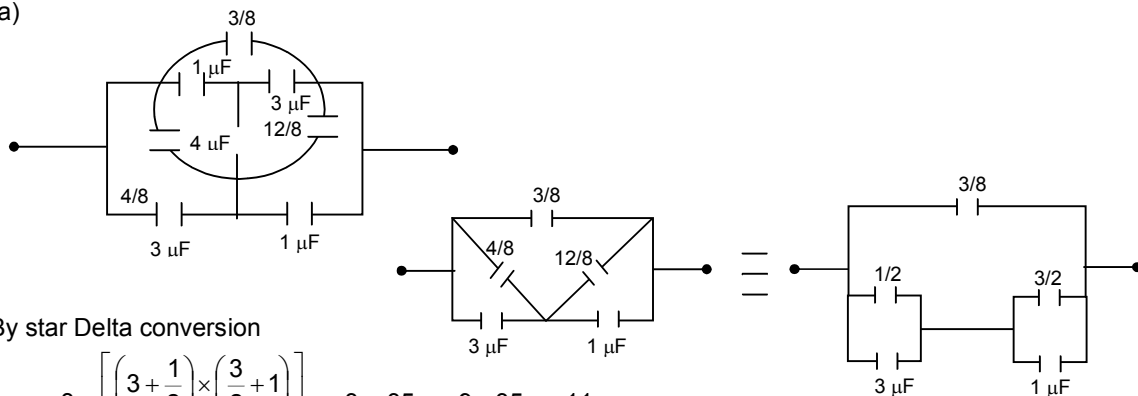

By star Delta conversion

$$C_{\text{eff}} = \frac{3}{8} + \left[\frac{\left(3 + \frac{1}{2}\right) \times \left(\frac{3}{2} + 1\right)}{\left(3 + \frac{1}{2}\right) + \left(\frac{3}{2} + 1\right)} \right] = \frac{3}{8} + \frac{35}{24} = \frac{9 + 35}{24} = \frac{44}{24} = \frac{11}{6} \mu F$$

(b)

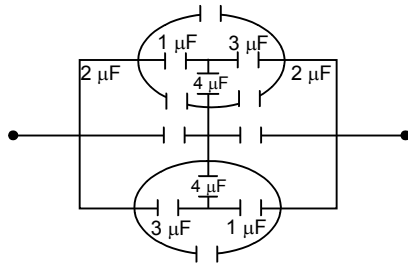

by star Delta convertor

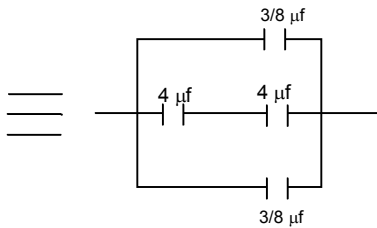
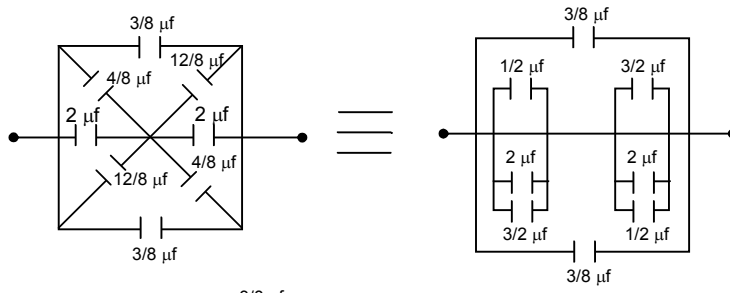

$$= \frac{3}{8} + \frac{16}{8} + \frac{3}{8} = \frac{11}{4} \mu\text{f}$$

(c)

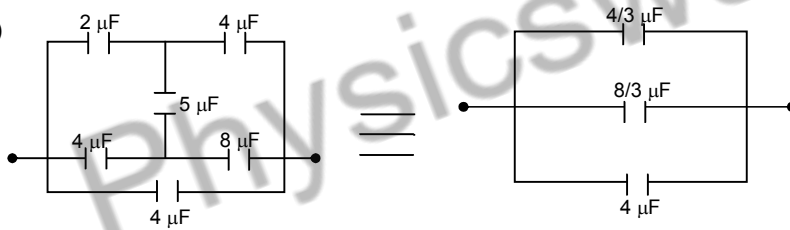

$$C_{\text{ef}} = \frac{4}{3} + \frac{8}{3} + 4 = 8 \mu\text{F}$$

(d)

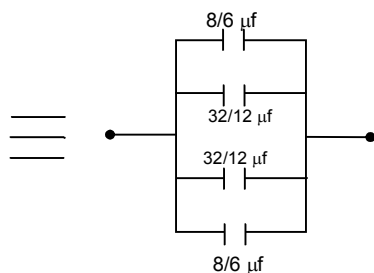
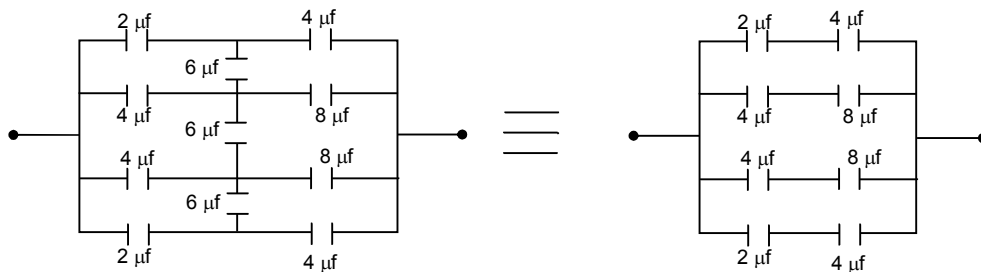

$$C_{\text{ef}} = \frac{3}{8} + \frac{32}{12} + \frac{32}{12} + \frac{8}{6} = \frac{16+32}{6} = 8 \mu\text{f}$$

27.

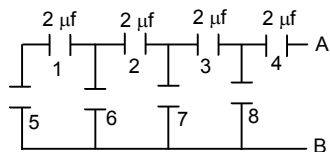

= C_5 and C_1 are in series

$$C_{eq} = \frac{2 \times 2}{2 + 2} = 1$$

This is parallel to $C_6 = 1 + 1 = 2$

Which is series to $C_2 = \frac{2 \times 2}{2 + 2} = 1$

Which is parallel to $C_7 = 1 + 1 = 2$

Which is series to $C_3 = \frac{2 \times 2}{2 + 2} = 1$

Which is parallel to $C_8 = 1 + 1 = 2$

This is series to $C_4 = \frac{2 \times 2}{2 + 2} = 1$

28.

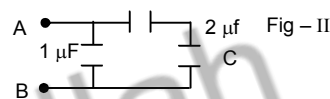
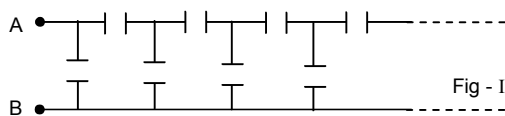

Let the equivalent capacitance be C . Since it is an infinite series. So, there will be negligible change if the arrangement is done as in Fig - II

$$C_{eq} = \frac{2 \times C}{2 + C} + 1 \Rightarrow C = \frac{2C + 2 + C}{2 + C}$$

$$\Rightarrow (2 + C) \times C = 3C + 2$$

$$\Rightarrow C^2 - C - 2 = 0$$

$$\Rightarrow (C - 2)(C + 1) = 0$$

$$C = -1 \text{ (Impossible)}$$

So, $C = 2 \mu\text{F}$

29.

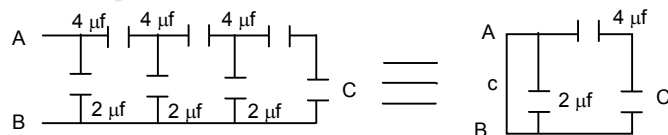

= C and $4 \mu\text{f}$ are in series

$$\text{So, } C_1 = \frac{4 \times C}{4 + C}$$

Then C_1 and $2 \mu\text{f}$ are parallel

$$C = C_1 + 2 \mu\text{f}$$

$$\Rightarrow \frac{4 \times C}{4 + C} + 2 \Rightarrow \frac{4C + 8 + 2C}{4 + C} = C$$

$$\Rightarrow 4C + 8 + 2C = 4C + C^2 = C^2 - 2C - 8 = 0$$

$$C = \frac{2 \pm \sqrt{4 + 4 \times 1 \times 8}}{2} = \frac{2 \pm \sqrt{36}}{2} = \frac{2 \pm 6}{2}$$

$$C = \frac{2 + 6}{2} = 4 \mu\text{f}$$

\therefore The value of C is $4 \mu\text{f}$

30. $q_1 = +2.0 \times 10^{-8} \text{ C}$ $q_2 = -1.0 \times 10^{-8} \text{ C}$
 $C = 1.2 \times 10^{-3} \mu\text{F} = 1.2 \times 10^{-9} \text{ F}$

$$\text{net } q = \frac{q_1 - q_2}{2} = \frac{3.0 \times 10^{-8}}{2}$$

$$V = \frac{q}{C} = \frac{3 \times 10^{-8}}{2} \times \frac{1}{1.2 \times 10^{-9}} = 12.5 \text{ V}$$

31. ∴ Given that

Capacitance = 10 μF

Charge = 20 μC

$$\therefore \text{The effective charge} = \frac{20 - 0}{2} = 10 \mu\text{F}$$

$$\therefore C = \frac{q}{V} \Rightarrow V = \frac{q}{C} = \frac{10}{10} = 1 \text{ V}$$

32. $q_1 = 1 \mu\text{C} = 1 \times 10^{-6} \text{ C}$ $C = 0.1 \mu\text{F} = 1 \times 10^{-7} \text{ F}$
 $q_2 = 2 \mu\text{C} = 2 \times 10^{-6} \text{ C}$

$$\text{net } q = \frac{q_1 - q_2}{2} = \frac{(1 - 2) \times 10^{-6}}{2} = -0.5 \times 10^{-6} \text{ C}$$

$$\text{Potential 'V'} = \frac{q}{C} = \frac{1 \times 10^{-7}}{-5 \times 10^{-7}} = -5 \text{ V}$$

But potential can never be (-)ve. So, $V = 5 \text{ V}$

33. Here three capacitors are formed

And each of

$$A = \frac{96}{\epsilon_0} \times 10^{-12} \text{ f.m.}$$

$$d = 4 \text{ mm} = 4 \times 10^{-3} \text{ m}$$

∴ Capacitance of a capacitor

$$C = \frac{\epsilon_0 A}{d} = \frac{\epsilon_0 \times 96 \times 10^{-12}}{4 \times 10^{-3}} = 24 \times 10^{-9} \text{ F.}$$

∴ As three capacitor are arranged is series

$$\text{So, } C_{eq} = \frac{C}{3} = \frac{24 \times 10^{-9}}{3} = 8 \times 10^{-9}$$

∴ The total charge to a capacitor = $8 \times 10^{-9} \times 10 = 8 \times 10^{-8} \text{ C}$

∴ The charge of a single Plate = $2 \times 8 \times 10^{-8} = 16 \times 10^{-8} = 0.16 \times 10^{-6} = 0.16 \mu\text{C}$.

34. (a) When charge of 1 μC is introduced to the B plate, we also get 0.5 μC charge on the upper surface of Plate 'A'.

(b) Given $C = 50 \mu\text{F} = 50 \times 10^{-9} \text{ F} = 5 \times 10^{-8} \text{ F}$

Now charge = $0.5 \times 10^{-6} \text{ C}$

$$V = \frac{q}{C} = \frac{5 \times 10^{-7} \text{ C}}{5 \times 10^{-8} \text{ F}} = 10 \text{ V}$$

35. Here given,

Capacitance of each capacitor, $C = 50 \mu\text{f} = 0.05 \mu\text{f}$

Charge $Q = 1 \mu\text{F}$ which is given to upper plate = 0.5 μC charge appear on outer and inner side of upper plate and 0.5 μC of charge also see on the middle.

(a) Charge of each plate = 0.5 μC

Capacitance = 0.5 μf

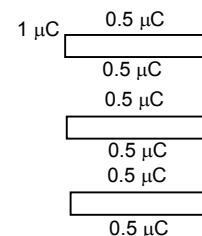
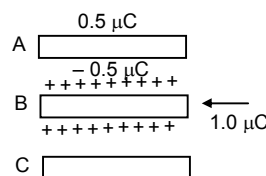
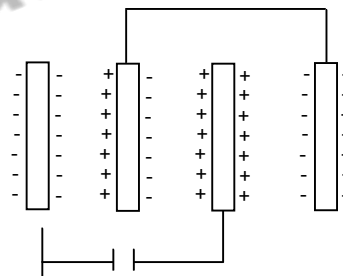
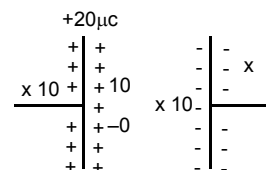

$$\therefore C = \frac{q}{V} \therefore V = \frac{q}{C} = \frac{0.5}{0.05} = 10 \text{ V}$$

(b) The charge on lower plate also = 0.5 μC
 Capacitance = 0.5 μF

$$\therefore C = \frac{q}{V} \Rightarrow V = \frac{q}{C} = \frac{0.5}{0.05} = 10 \text{ V}$$

\therefore The potential in 10 V

36. $C_1 = 20 \text{ PF} = 20 \times 10^{-12} \text{ F}$, $C_2 = 50 \text{ PF} = 50 \times 10^{-12} \text{ F}$

$$\text{Effective } C = \frac{C_1 C_2}{C_1 + C_2} = \frac{2 \times 10^{-11} \times 5 \times 10^{-11}}{2 \times 10^{-11} + 5 \times 10^{-11}} = 1.428 \times 10^{-11} \text{ F}$$

$$\text{Charge 'q'} = 1.428 \times 10^{-11} \times 6 = 8.568 \times 10^{-11} \text{ C}$$

$$V_1 = \frac{q}{C_1} = \frac{8.568 \times 10^{-11}}{2 \times 10^{-11}} = 4.284 \text{ V}$$

$$V_2 = \frac{q}{C_2} = \frac{8.568 \times 10^{-11}}{5 \times 10^{-11}} = 1.71 \text{ V}$$

Energy stored in each capacitor

$$E_1 = (1/2) C_1 V_1^2 = (1/2) \times 2 \times 10^{-11} \times (4.284)^2 = 18.35 \times 10^{-11} \approx 184 \text{ PJ}$$

$$E_2 = (1/2) C_2 V_2^2 = (1/2) \times 5 \times 10^{-11} \times (1.71)^2 = 7.35 \times 10^{-11} \approx 73.5 \text{ PJ}$$

37. $\therefore C_1 = 4 \mu\text{F}$, $C_2 = 6 \mu\text{F}$, $V = 20 \text{ V}$

$$\text{Eq. capacitor } C_{\text{eq}} = \frac{C_1 C_2}{C_1 + C_2} = \frac{4 \times 6}{4 + 6} = 2.4$$

\therefore The Eq Capacitance $C_{\text{eq}} = 2.5 \mu\text{F}$

\therefore The energy supplied by the battery to each plate

$$E = (1/2) CV^2 = (1/2) \times 2.4 \times 20^2 = 480 \mu\text{J}$$

\therefore The energy supplies by the battery to capacitor = $2 \times 480 = 960 \mu\text{J}$

38. $C = 10 \mu\text{F} = 10 \times 10^{-6} \text{ F}$

For a & d

$$q = 4 \times 10^{-4} \text{ C}$$

$$c = 10^{-5} \text{ F}$$

$$E = \frac{1}{2} \frac{q^2}{c} = \frac{1}{2} \frac{(4 \times 10^{-4})^2}{10^{-5}} = 8 \times 10^{-3} \text{ J} = 8 \text{ mJ}$$

For b & c

$$q = 4 \times 10^{-4} \text{ C}$$

$$C_{\text{eq}} = 2c = 2 \times 10^{-5} \text{ F}$$

$$V = \frac{4 \times 10^{-4}}{2 \times 10^{-5}} = 20 \text{ V}$$

$$E = (1/2) cV^2 = (1/2) \times 10^{-5} \times (20)^2 = 2 \times 10^{-3} \text{ J} = 2 \text{ mJ}$$

39. Stored energy of capacitor $C_1 = 4.0 \text{ J}$

$$= \frac{1}{2} \frac{q^2}{c^2} = 4.0 \text{ J}$$

When then connected, the charge shared

$$\frac{1}{2} \frac{q_1^2}{c^2} = \frac{1}{2} \frac{q_2^2}{c^2} \Rightarrow q_1 = q_2$$

So that the energy should divided.

\therefore The total energy stored in the two capacitors each is 2 J.

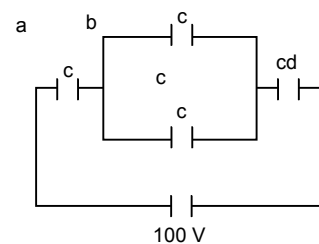
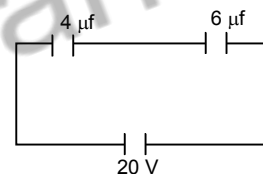

40. Initial charge stored = $C \times V = 12 \times 2 \times 10^{-6} = 24 \times 10^{-6} \text{ C}$
 Let the charges on 2 & 4 capacitors be q_1 & q_2 respectively

$$\text{There, } V = \frac{q_1}{C_1} = \frac{q_2}{C_2} \Rightarrow \frac{q_1}{2} = \frac{q_2}{4} \Rightarrow q_2 = 2q_1.$$

$$\text{or } q_1 + q_2 = 24 \times 10^{-6} \text{ C}$$

$$\Rightarrow q_1 = 8 \times 10^{-6} \mu\text{C}$$

$$q_2 = 2q_1 = 2 \times 8 \times 10^{-6} = 16 \times 10^{-6} \mu\text{C}$$

$$E_1 = (1/2) \times C_1 \times V_1^2 = (1/2) \times 2 \times \left(\frac{8}{2}\right)^2 = 16 \mu\text{J}$$

$$E_2 = (1/2) \times C_2 \times V_2^2 = (1/2) \times 4 \times \left(\frac{8}{4}\right)^2 = 8 \mu\text{J}$$

41. Charge = Q

Radius of sphere = R

\therefore Capacitance of the sphere = $C = 4\pi\epsilon_0 R$

$$\text{Energy} = \frac{1}{2} \frac{Q^2}{C} = \frac{1}{2} \frac{Q^2}{4\pi\epsilon_0 R} = \frac{Q^2}{8\pi\epsilon_0 R}$$

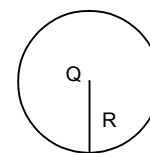

42. $Q = CV = 4\pi\epsilon_0 R \times V$

$$E = \frac{1}{2} \frac{q^2}{C} \quad [\because 'C' \text{ in a spherical shell} = 4\pi\epsilon_0 R]$$

$$E = \frac{1}{2} \frac{16\pi^2 \epsilon_0^2 \times R^2 \times V^2}{4\pi\epsilon_0 \times 2R} = 2\pi\epsilon_0 R V^2 \quad ['C' \text{ of bigger shell} = 4\pi\epsilon_0 R]$$

43. $\sigma = 1 \times 10^{-4} \text{ C/m}^2$

$$a = 1 \text{ cm} = 1 \times 10^{-2} \text{ m}$$

$$a^3 = 10^{-6} \text{ m}^3$$

$$\text{The energy stored in the plane} = \frac{1}{2} \frac{\sigma^2}{\epsilon_0} = \frac{1}{2} \frac{(1 \times 10^{-4})^2}{8.85 \times 10^{-12}} = \frac{10^4}{17.7} = 564.97$$

The necessary electro static energy stored in a cubical volume of edge 1 cm in front of the plane

$$= \frac{1}{2} \frac{\sigma^2}{\epsilon_0} a^3 = 265 \times 10^{-6} = 5.65 \times 10^{-4} \text{ J}$$

44. area = $a = 20 \text{ cm}^2 = 2 \times 10^{-2} \text{ m}^2$

$$d = \text{separation} = 1 \text{ mm} = 10^{-3} \text{ m}$$

$$C_i = \frac{\epsilon_0 \times 2 \times 10^{-3}}{10^{-3}} = 2\epsilon_0$$

$$C_f = \frac{\epsilon_0 \times 2 \times 10^{-3}}{2 \times 10^{-3}} = \epsilon_0$$

$$q_i = 24 \epsilon_0$$

$$q_f = 12 \epsilon_0$$

So, q flown out $12 \epsilon_0$. ie, $q_i - q_f$.

(a) So, $q = 12 \times 8.85 \times 10^{-12} = 106.2 \times 10^{-12} \text{ C} = 1.06 \times 10^{-10} \text{ C}$

(b) Energy absorbed by battery during the process

$$= q \times v = 1.06 \times 10^{-10} \text{ C} \times 12 = 12.7 \times 10^{-10} \text{ J}$$

(c) Before the process

$$E_i = (1/2) \times C_i \times v^2 = (1/2) \times 2 \times 8.85 \times 10^{-12} \times 144 = 12.7 \times 10^{-10} \text{ J}$$

After the force

$$E_f = (1/2) \times C_f \times v^2 = (1/2) \times 8.85 \times 10^{-12} \times 144 = 6.35 \times 10^{-10} \text{ J}$$

(d) Workdone = Force \times Distance

$$= \frac{1}{2} \frac{q^2}{\epsilon_0 A} = 1 \times 10^3 = \frac{1}{2} \times \frac{12 \times 12 \times \epsilon_0 \times \epsilon_0 \times 10^{-3}}{\epsilon_0 \times 2 \times 10^{-3}}$$

(e) From (c) and (d) we have calculated, the energy loss by the separation of plates is equal to the work done by the man on plate. Hence no heat is produced in transformer.

45. (a) Before reconnection

$$C = 100 \mu\text{f} \quad V = 24 \text{ V}$$

$$q = CV = 2400 \mu\text{c} \text{ (Before reconnection)}$$

After connection

$$\text{When } C = 100 \mu\text{f} \quad V = 12 \text{ V}$$

$$q = CV = 1200 \mu\text{c} \text{ (After connection)}$$

(b) $C = 100, \quad V = 12 \text{ V}$

$$\therefore q = CV = 1200 \text{ v}$$

(c) We know $V = \frac{W}{q}$

$$W = vq = 12 \times 1200 = 14400 \text{ J} = 14.4 \text{ mJ}$$

The work done on the battery.

(d) Initial electrostatic field energy $U_i = (1/2) CV_1^2$

Final Electrostatic field energy $U_f = (1/2) CV_2^2$

\therefore Decrease in Electrostatic

$$\text{Field energy} = (1/2) CV_1^2 - (1/2) CV_2^2$$

$$= (1/2) C(V_1^2 - V_2^2) = (1/2) \times 100(576 - 144) = 21600 \text{ J}$$

$$\therefore \text{Energy} = 21600 \text{ j} = 21.6 \text{ mJ}$$

(e) After reconnection

$$C = 100 \mu\text{c}, \quad V = 12 \text{ v}$$

$$\therefore \text{The energy appeared} = (1/2) CV^2 = (1/2) \times 100 \times 144 = 7200 \text{ J} = 7.2 \text{ mJ}$$

This amount of energy is developed as heat when the charge flow through the capacitor.

46. (a) Since the switch was open for a long time, hence the charge flown must be due to the both, when the switch is closed.

$$C_{\text{ef}} = C/2$$

$$\text{So } q = \frac{E \times C}{2}$$

(b) Workdone = $q \times v = \frac{EC}{2} \times E = \frac{E^2 C}{2}$

$$(c) E_i = \frac{1}{2} \times \frac{C}{2} \times E^2 = \frac{E^2 C}{4}$$

$$E_f = (1/2) \times C \times E^2 = \frac{E^2 C}{2}$$

$$E_i - E_f = \frac{E^2 C}{4}$$

(d) The net charge in the energy is wasted as heat.

47. $C_1 = 5 \mu\text{f} \quad V_1 = 24 \text{ V}$

$$q_1 = C_1 V_1 = 5 \times 24 = 120 \mu\text{c}$$

and $C_2 = 6 \mu\text{f} \quad V_2 = 12 \text{ V}$

$$q_2 = C_2 V_2 = 6 \times 12 = 72 \mu\text{c}$$

\therefore Energy stored on first capacitor

$$E_1 = \frac{1}{2} \frac{q_1^2}{C_1} = \frac{1}{2} \times \frac{(120)^2}{5} = 1440 \text{ J} = 1.44 \text{ mJ}$$

Energy stored on 2nd capacitor

$$E_2 = \frac{1}{2} \frac{q_2^2}{C_2} = \frac{1}{2} \times \frac{(72)^2}{6} = 432 \text{ J} = 4.32 \text{ mJ}$$

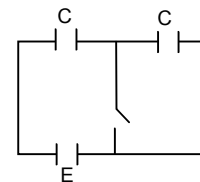

(b) C_1V_1 C_2V_2

Let the effective potential = V

$$V = \frac{C_1V_1 - C_2V_2}{C_1 + C_2} = \frac{120 - 72}{5 + 6} = 4.36$$

The new charge $C_1V = 5 \times 4.36 = 21.8 \mu\text{C}$

and $C_2V = 6 \times 4.36 = 26.2 \mu\text{C}$

(c) $U_1 = (1/2) C_1V^2$

$U_2 = (1/2) C_2V^2$

$U_f = (1/2) V^2 (C_1 + C_2) = (1/2) (4.36)^2 (5 + 6) = 104.5 \times 10^{-6} \text{ J} = 0.1045 \text{ mJ}$

But $U_i = 1.44 + 0.433 = 1.873$

\therefore The loss in KE = $1.873 - 0.1045 = 1.7687 = 1.77 \text{ mJ}$

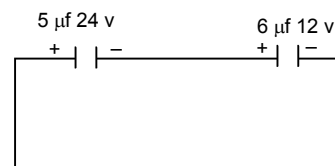

48.

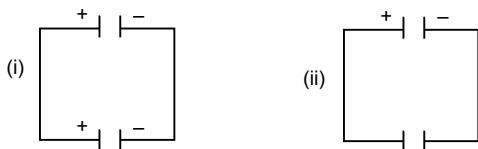

When the capacitor is connected to the battery, a charge $Q = CE$ appears on one plate and $-Q$ on the other. When the polarity is reversed, a charge $-Q$ appears on the first plate and $+Q$ on the second. A charge $2Q$, therefore passes through the battery from the negative to the positive terminal.

The battery does a work.

$W = Q \times E = 2QE = 2CE^2$

In this process. The energy stored in the capacitor is the same in the two cases. Thus the workdone by battery appears as heat in the connecting wires. The heat produced is therefore,

$2CE^2 = 2 \times 5 \times 10^{-6} \times 144 = 144 \times 10^{-5} \text{ J} = 1.44 \text{ mJ}$ [have $C = 5 \mu\text{f}$ $V = E = 12\text{V}$]

49. $A = 20 \text{ cm} \times 20 \text{ cm} = 4 \times 10^{-2} \text{ m}^2$

$d = 1 \text{ m} = 1 \times 10^{-3} \text{ m}$

$k = 4$ $t = d$

$$C = \frac{\epsilon_0 A}{d - t + \frac{t}{k}} = \frac{\epsilon_0 A}{d - d + \frac{d}{k}} = \frac{\epsilon_0 A k}{d}$$

$= \frac{8.85 \times 10^{-12} \times 4 \times 10^{-2} \times 4}{1 \times 10^{-3}} = 141.6 \times 10^{-9} \text{ F} = 1.42 \text{ nf}$

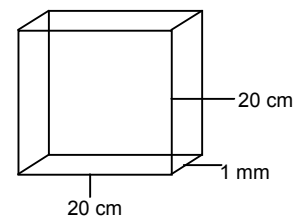

50. Dielectric const. = 4

$F = 1.42 \text{ nf}$, $V = 6 \text{ V}$

Charge supplied = $q = CV = 1.42 \times 10^{-9} \times 6 = 8.52 \times 10^{-9} \text{ C}$

Charge Induced = $q(1 - 1/k) = 8.52 \times 10^{-9} \times (1 - 0.25) = 6.39 \times 10^{-9} = 6.4 \text{ nc}$

Net charge appearing on one coated surface = $\frac{8.52 \mu\text{C}}{4} = 2.13 \text{ nc}$

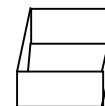

51. Here

Plate area = $100 \text{ cm}^2 = 10^{-2} \text{ m}^2$

Separation $d = .5 \text{ cm} = 5 \times 10^{-3} \text{ m}$

Thickness of metal $t = .4 \text{ cm} = 4 \times 10^{-3} \text{ m}$

$$C = \frac{\epsilon_0 A}{d - t + \frac{t}{k}} = \frac{\epsilon_0 A}{d - t} = \frac{8.585 \times 10^{-12} \times 10^{-2}}{(5 - 4) \times 10^{-3}} = 88 \text{ pF}$$

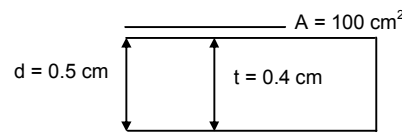

Here the capacitance is independent of the position of metal. At any position the net separation is $d - t$. As d is the separation and t is the thickness.

52. Initial charge stored = 50 μc

Let the dielectric constant of the material induced be 'k'.
Now, when the extra charge flown through battery is 100.
So, net charge stored in capacitor = 150 μc

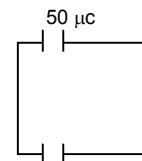

$$\text{Now } C_1 = \frac{\epsilon_0 A}{d} \quad \text{or} \quad \frac{q_1}{V} = \frac{\epsilon_0 A}{d} \quad \dots(1)$$

$$C_2 = \frac{\epsilon_0 Ak}{d} \quad \text{or,} \quad \frac{q_2}{V} = \frac{\epsilon_0 Ak}{d} \quad \dots(2)$$

Deviding (1) and (2) we get $\frac{q_1}{q_2} = \frac{1}{k}$

$$\Rightarrow \frac{50}{150} = \frac{1}{k} \Rightarrow k = 3$$

53. $C = 5 \mu\text{f}$ $V = 6 \text{ V}$ $d = 2 \text{ mm} = 2 \times 10^{-3} \text{ m}$.

(a) the charge on the +ve plate

$$q = CV = 5 \mu\text{f} \times 6 \text{ V} = 30 \mu\text{c}$$

(b) $E = \frac{V}{d} = \frac{6\text{V}}{2 \times 10^{-3} \text{ m}} = 3 \times 10^3 \text{ V/M}$

(c) $d = 2 \times 10^{-3} \text{ m}$
 $t = 1 \times 10^{-3} \text{ m}$

$$k = 5 \text{ or } C = \frac{\epsilon_0 A}{d} \Rightarrow 5 \times 10^{-6} = \frac{8.85 \times A \times 10^{-12}}{2 \times 10^{-3}} \times 10^{-9} \Rightarrow A = \frac{10^4}{8.85}$$

When the dielectric placed on it

$$C_1 = \frac{\epsilon_0 A}{d - t + \frac{t}{k}} = \frac{8.85 \times 10^{-12} \times \frac{10^4}{8.85}}{10^{-3} + \frac{10^{-3}}{5}} = \frac{10^{-12} \times 10^4 \times 5}{6 \times 10^{-3}} = \frac{5}{6} \times 10^{-5} = 0.00000833 = 8.33 \mu\text{F}.$$

(d) $C = 5 \times 10^{-6} \text{ f}$. $V = 6 \text{ V}$

$$\therefore Q = CV = 3 \times 10^{-5} \text{ f} = 30 \mu\text{f}$$

$$C' = 8.3 \times 10^{-6} \text{ f}$$

$$V = 6 \text{ V}$$

$$\therefore Q' = C'V = 8.3 \times 10^{-6} \times 6 \approx 50 \mu\text{F}$$

$$\therefore \text{charge flown} = Q' - Q = 20 \mu\text{F}$$

54. Let the capacitances be C_1 & C_2 net capacitance ' C ' = $\frac{C_1 C_2}{C_1 + C_2}$

$$\text{Now } C_1 = \frac{\epsilon_0 Ak_1}{d_1} \quad C_2 = \frac{\epsilon_0 Ak_2}{d_2}$$

$$C = \frac{\frac{\epsilon_0 Ak_1}{d_1} \times \frac{\epsilon_0 Ak_2}{d_2}}{\frac{\epsilon_0 Ak_1}{d_1} + \frac{\epsilon_0 Ak_2}{d_2}} = \frac{\epsilon_0 A \left(\frac{k_1 k_2}{d_1 d_2} \right)}{\epsilon_0 A \left(\frac{k_1 d_2 + k_2 d_1}{d_1 d_2} \right)} = \frac{8.85 \times 10^{-12} \times 10^{-2} \times 24}{6 \times 4 \times 10^{-3} + 4 \times 6 \times 10^{-3}}$$

$$= 4.425 \times 10^{-11} \text{ C} = 44.25 \text{ pc.}$$

55. $A = 400 \text{ cm}^2 = 4 \times 10^{-2} \text{ m}^2$

$$d = 1 \text{ cm} = 1 \times 10^{-3} \text{ m}$$

$$V = 160 \text{ V}$$

$$t = 0.5 = 5 \times 10^{-4} \text{ m}$$

$$k = 5$$

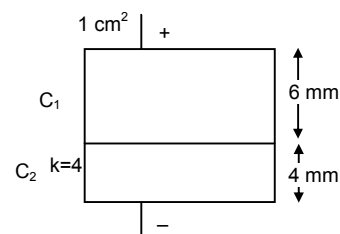

$$C = \frac{\epsilon_0 A}{d - t + \frac{t}{k}} = \frac{8.85 \times 10^{-12} \times 4 \times 10^{-2}}{10^{-3} - 5 \times 10^{-4} + \frac{5 \times 10^{-4}}{5}} = \frac{35.4 \times 10^{-4}}{10^{-3} - 0.5}$$

56. (a) Area = A
Separation = d

$$C_1 = \frac{\epsilon_0 A k_1}{d/2} \quad C_2 = \frac{\epsilon_0 A k_2}{d/2}$$

$$C = \frac{C_1 C_2}{C_1 + C_2} = \frac{\frac{2\epsilon_0 A k_1}{d} \times \frac{2\epsilon_0 A k_2}{d}}{\frac{2\epsilon_0 A k_1}{d} + \frac{2\epsilon_0 A k_2}{d}} = \frac{(2\epsilon_0 A)^2 k_1 k_2}{(2\epsilon_0 A) \frac{k_1 d + k_2 d}{d}} = \frac{2k_1 k_2 \epsilon_0 A}{d(k_1 + k_2)}$$

_____ K₁
_____ K₂

(b) similarly

$$\frac{1}{C} = \frac{1}{C_1} + \frac{1}{C_2} + \frac{1}{C_3} = \frac{1}{\frac{3\epsilon_0 A k_1}{d}} + \frac{1}{\frac{3\epsilon_0 A k_2}{d}} + \frac{1}{\frac{3\epsilon_0 A k_3}{d}}$$

$$= \frac{d}{3\epsilon_0 A} \left[\frac{1}{k_1} + \frac{1}{k_2} + \frac{1}{k_3} \right] = \frac{d}{3\epsilon_0 A} \left[\frac{k_2 k_3 + k_1 k_3 + k_1 k_2}{k_1 k_2 k_3} \right]$$

$$\therefore C = \frac{3\epsilon_0 A k_1 k_2 k_3}{d(k_1 k_2 + k_2 k_3 + k_1 k_3)}$$

(c) C = C₁ + C₂

$$= \frac{\epsilon_0 \frac{A}{2} k_1}{d} + \frac{\epsilon_0 \frac{A}{2} k_2}{d} = \frac{\epsilon_0 A}{2d} (k_1 + k_2)$$

57.

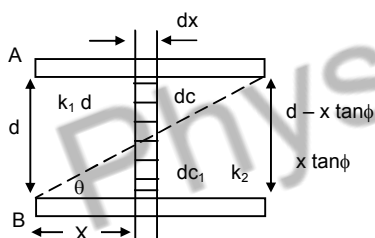

Consider an elemental capacitor of width dx at a distance ' x ' from one end. It is constituted of two capacitor elements of dielectric constants k_1 and k_2 with plate separation $x \tan \phi$ and $d - x \tan \phi$ respectively in series

$$\frac{1}{dcR} = \frac{1}{dc_1} + \frac{1}{dc_2} = \frac{x \tan \phi}{\epsilon_0 k_2 (bdx)} + \frac{d - x \tan \phi}{\epsilon_0 k_1 (bdx)}$$

$$dcR = \frac{\epsilon_0 bdx}{\frac{x \tan \phi}{k_2} + \frac{d - x \tan \phi}{k_1}}$$

$$\text{or } C_R = \epsilon_0 b k_1 k_2 \int \frac{dx}{k_2 d + (k_1 - k_2) x \tan \phi}$$

$$= \frac{\epsilon_0 b k_1 k_2}{\tan \phi (k_1 - k_2)} [\log_e k_2 d + (k_1 - k_2) x \tan \phi] a$$

$$= \frac{\epsilon_0 b k_1 k_2}{\tan \phi (k_1 - k_2)} [\log_e k_2 d + (k_1 - k_2) a \tan \phi - \log_e k_2 d]$$

$$\therefore \tan \phi = \frac{d}{a} \text{ and } A = a \times a$$

$$C_R = \frac{\epsilon_0 a k_1 k_2}{d(k_1 - k_2)} \left[\log_e \left(\frac{k_1}{k_2} \right) \right]$$

$$C_R = \frac{\epsilon_0 a^2 k_1 k_2}{d(k_1 - k_2)} \left[\log_e \left(\frac{k_1}{k_2} \right) \right]$$

$$C_R = \frac{\epsilon_0 a^2 k_1 k_2}{d(k_1 - k_2)} \ln \frac{k_1}{k_2}$$

58.

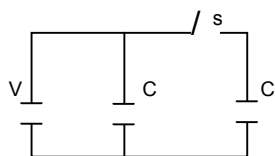

I. Initially when switch 's' is closed

$$\text{Total Initial Energy} = (1/2) CV^2 + (1/2) CV^2 = CV^2 \quad \dots(1)$$

II. When switch is open the capacitance in each of capacitors varies, hence the energy also varies.

i.e. in case of 'B', the charge remains

Same i.e. cv

$$C_{\text{eff}} = 3C$$

$$E = \frac{1}{2} \times \frac{q^2}{c} = \frac{1}{2} \times \frac{c^2 v^2}{3c} = \frac{cv^2}{6}$$

In case of 'A'

$$C_{\text{eff}} = 3c$$

$$E = \frac{1}{2} \times C_{\text{eff}} v^2 = \frac{1}{2} \times 3c \times v^2 = \frac{3}{2} cv^2$$

$$\text{Total final energy} = \frac{cv^2}{6} + \frac{3cv^2}{2} = \frac{10cv^2}{6}$$

$$\text{Now, } \frac{\text{Initial Energy}}{\text{Final Energy}} = \frac{cv^2}{\frac{10cv^2}{6}} = 3$$

59. Before inserting

$$C = \frac{\epsilon_0 A}{d} C$$

$$Q = \frac{\epsilon_0 AV}{d} C$$

After inserting

$$C = \frac{\epsilon_0 A}{d} = \frac{\epsilon_0 Ak}{d}$$

$$Q_1 = \frac{\epsilon_0 Ak}{d} V$$

The charge flow through the power supply

$$Q = Q_1 - Q$$

$$= \frac{\epsilon_0 AkV}{d} - \frac{\epsilon_0 AV}{d} = \frac{\epsilon_0 AV}{d} (k - 1)$$

Workdone = Charge in emf

$$= \frac{1}{2} \frac{Q^2}{C} = \frac{1}{2} \frac{\frac{\epsilon_0^2 A^2 V^2}{d^2} (k - 1)^2}{\frac{\epsilon_0 A}{d} (k - 1)} = \frac{\epsilon_0 AV^2}{2d} (k - 1)$$

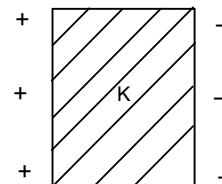

60. Capacitance = $100 \mu\text{F} = 10^{-4} \text{ F}$

P.d = 30 V

(a) $q = CV = 10^{-4} \times 50 = 5 \times 10^{-3} \text{ C} = 5 \text{ mc}$

Dielectric constant = 2.5

(b) New $C = C' = 2.5 \times C = 2.5 \times 10^{-4} \text{ F}$

New p.d = $\frac{q}{C'}$ [\therefore 'q' remains same after disconnection of battery]

= $\frac{5 \times 10^{-3}}{2.5 \times 10^{-4}} = 20 \text{ V.}$

(c) In the absence of the dielectric slab, the charge that must have produced

$C \times V = 10^{-4} \times 20 = 2 \times 10^{-3} \text{ C} = 2 \text{ mc}$

(d) Charge induced at a surface of the dielectric slab

= $q (1 - 1/k)$ (where k = dielectric constant, q = charge of plate)

= $5 \times 10^{-3} \left(1 - \frac{1}{2.5}\right) = 5 \times 10^{-3} \times \frac{3}{5} = 3 \times 10^{-3} = 3 \text{ mc.}$

61. Here we should consider a capacitor C_{ac} and C_{bc} in series

$C_{ac} = \frac{4\pi\epsilon_0ack}{k(c-a)}$

$C_{bc} = \frac{4\pi\epsilon_0bc}{(b-c)}$

$\frac{1}{C} = \frac{1}{C_{ac}} + \frac{1}{C_{bc}}$

= $\frac{(c-a)}{4\pi\epsilon_0ack} + \frac{(b-c)}{4\pi\epsilon_0bc} = \frac{b(c-a) + ka(b-c)}{k4\pi\epsilon_0abc}$

$C = \frac{4\pi\epsilon_0kabc}{ka(b-c) + b(c-a)}$

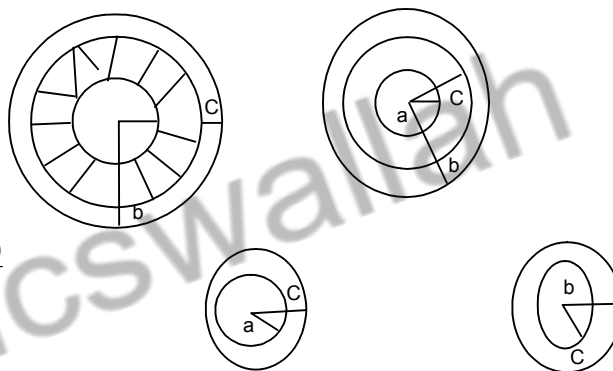

62. These three metallic hollow spheres form two spherical capacitors, which are connected in series.

Solving them individually, for (1) and (2)

$C_1 = \frac{4\pi\epsilon_0ab}{b-a}$ (\therefore for a spherical capacitor formed by two spheres of radii $R_2 > R_1$)

$C = \frac{4\pi\epsilon_0R_2R_1}{R_2 - R_1}$

Similarly for (2) and (3)

$C_2 = \frac{4\pi\epsilon_0bc}{c-b}$

$C_{\text{eff}} = \frac{C_1 C_2}{C_1 + C_2} = \frac{\frac{(4\pi\epsilon_0)^2 ab^2c}{(b-a)(c-a)}}{4\pi\epsilon_0 \left[\frac{ab(c-b) + bc(b-a)}{(b-a)(c-b)} \right]}$

= $\frac{4\pi\epsilon_0 ab^2c}{abc - ab^2 + b^2c - abc} = \frac{4\pi\epsilon_0 ab^2c}{b^2(c-a)} = \frac{4\pi\epsilon_0 ac}{c-a}$

63. Here we should consider two spherical capacitor of capacitance

C_{ab} and C_{bc} in series

$C_{ab} = \frac{4\pi\epsilon_0abk}{(b-a)}$

$C_{bc} = \frac{4\pi\epsilon_0bc}{(c-b)}$

$$\frac{1}{C} = \frac{1}{C_{ab}} + \frac{1}{C_{bc}} = \frac{(b-a)}{4\pi\epsilon_0 abk} + \frac{(c-b)}{4\pi\epsilon_0 bc} = \frac{c(b-a) + ka(c-b)}{k4\pi\epsilon_0 abc}$$

$$C = \frac{4\pi\epsilon_0 kabc}{c(b-a) + ka(c-b)}$$

64. $Q = 12 \mu\text{C}$

$V = 1200 \text{ V}$

$$\frac{V}{d} = 3 \times 10^{-6} \frac{V}{\text{m}}$$

$$d = \frac{V}{(V/d)} = \frac{1200}{3 \times 10^{-6}} = 4 \times 10^{-4} \text{ m}$$

$$c = \frac{Q}{V} = \frac{12 \times 10^{-6}}{1200} = 10^{-8} \text{ f}$$

$$\therefore C = \frac{\epsilon_0 A}{d} = 10^{-8} \text{ f}$$

$$\Rightarrow A = \frac{10^{-8} \times d}{\epsilon_0} = \frac{10^{-8} \times 4 \times 10^{-4}}{8.854 \times 10^{-4}} = 0.45 \text{ m}^2$$

65. $A = 100 \text{ cm}^2 = 10^{-2} \text{ m}^2$

$d = 1 \text{ cm} = 10^{-2} \text{ m}$

$V = 24 V_0$

$$\therefore \text{The capacitance } C = \frac{\epsilon_0 A}{d} = \frac{8.85 \times 10^{-12} \times 10^{-2}}{10^{-2}} = 8.85 \times 10^{-12}$$

$$\therefore \text{The energy stored } C_1 = (1/2) CV^2 = (1/2) \times 10^{-12} \times (24)^2 = 2548.8 \times 10^{-12}$$

$$\therefore \text{The forced attraction between the plates} = \frac{C_1}{d} = \frac{2548.8 \times 10^{-12}}{10^{-2}} = 2.54 \times 10^{-7} \text{ N.}$$

66.

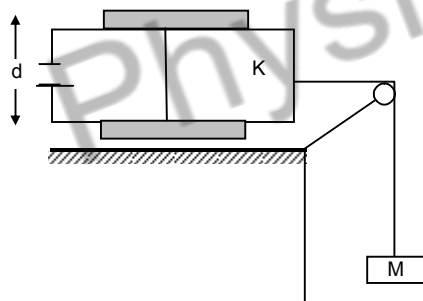

We know

In this particular case the electric field attracts the dielectric into the capacitor with a force $\frac{\epsilon_0 bV^2(k-1)}{2d}$

Where b – Width of plates

k – Dielectric constant

d – Separation between plates

$V = E$ = Potential difference.

Hence in this case the surfaces are frictionless, this force is counteracted by the weight.

$$\text{So, } \frac{\epsilon_0 bE^2(k-1)}{2d} = Mg$$

$$\Rightarrow M = \frac{\epsilon_0 bE^2(k-1)}{2dg}$$

67.

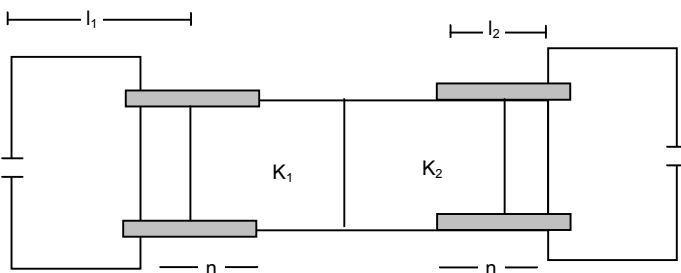

(a) Consider the left side

The plate area of the part with the dielectric is by its capacitance

$$C_1 = \frac{k_1 \epsilon_0 b x}{d} \text{ and with out dielectric } C_2 = \frac{\epsilon_0 b (L_1 - x)}{d}$$

These are connected in parallel

$$C = C_1 + C_2 = \frac{\epsilon_0 b}{d} [L_1 + x(k_1 - 1)]$$

Let the potential V_1

$$U = (1/2) C V_1^2 = \frac{\epsilon_0 b V_1^2}{2d} [L_1 + x(k_1 - 1)] \quad \dots(1)$$

Suppose dielectric slab is attracted by electric field and an external force F consider the part dx which makes inside further, As the potential difference remains constant at V .

The charge supply, $dq = (dc) v$ to the capacitor

The work done by the battery is $dw_b = v \cdot dq = (dc) v^2$

The external force F does a work $dw_e = (-f \cdot dx)$

during a small displacement

The total work done in the capacitor is $dw_b + dw_e = (dc) v^2 - f dx$

This should be equal to the increase dv in the stored energy.

Thus $(1/2) (dk) v^2 = (dc) v^2 - f dx$

$$f = \frac{1}{2} v^2 \frac{dc}{dx}$$

from equation (1)

$$F = \frac{\epsilon_0 b V_1^2}{2d} (k_1 - 1)$$

$$\Rightarrow V_1^2 = \frac{F \times 2d}{\epsilon_0 b (k_1 - 1)} \Rightarrow V_1 = \sqrt{\frac{F \times 2d}{\epsilon_0 b (k_1 - 1)}}$$

$$\text{For the right side, } V_2 = \sqrt{\frac{F \times 2d}{\epsilon_0 b (k_2 - 1)}}$$

$$\frac{V_1}{V_2} = \frac{\sqrt{\frac{F \times 2d}{\epsilon_0 b (k_1 - 1)}}}{\sqrt{\frac{F \times 2d}{\epsilon_0 b (k_2 - 1)}}}$$

$$\Rightarrow \frac{V_1}{V_2} = \frac{\sqrt{k_2 - 1}}{\sqrt{k_1 - 1}}$$

\therefore The ratio of the emf of the left battery to the right battery = $\frac{\sqrt{k_2 - 1}}{\sqrt{k_1 - 1}}$

68. Capacitance of the portion with dielectrics,

$$C_1 = \frac{k\epsilon_0 A}{\ell d}$$

Capacitance of the portion without dielectrics,

$$C_2 = \frac{\epsilon_0(\ell - a)A}{\ell d}$$

$$\therefore \text{Net capacitance } C = C_1 + C_2 = \frac{\epsilon_0 A}{\ell d} [ka + (\ell - a)]$$

$$C = \frac{\epsilon_0 A}{\ell d} [\ell + a(k - 1)]$$

Consider the motion of dielectric in the capacitor.

Let it further move a distance dx , which causes an increase of capacitance by dc

$$\therefore dQ = (dc) E$$

$$\text{The work done by the battery } dw = Vdq = E (dc) E = E^2 dc$$

Let force acting on it be f

$$\therefore \text{Work done by the force during the displacement, } dx = f dx$$

$$\therefore \text{Increase in energy stored in the capacitor}$$

$$\Rightarrow (1/2) (dc) E^2 = (dc) E^2 - f dx$$

$$\Rightarrow f dx = (1/2) (dc) E^2 \Rightarrow f = \frac{1}{2} \frac{E^2 dc}{dx}$$

$$C = \frac{\epsilon_0 A}{\ell d} [\ell + a(k - 1)] \quad (\text{here } x = a)$$

$$\Rightarrow \frac{dc}{da} = \frac{-d}{da} \left[\frac{\epsilon_0 A}{\ell d} \{ \ell + a(k - 1) \} \right]$$

$$\Rightarrow \frac{\epsilon_0 A}{\ell d} (k - 1) = \frac{dc}{dx}$$

$$\Rightarrow f = \frac{1}{2} E^2 \frac{dc}{dx} = \frac{1}{2} E^2 \left\{ \frac{\epsilon_0 A}{\ell d} (k - 1) \right\}$$

$$\therefore a_d = \frac{f}{m} = \frac{E^2 \epsilon_0 A (k - 1)}{2 \ell d m} \quad \therefore (\ell - a) = \frac{1}{2} a_d t^2$$

$$\Rightarrow t = \sqrt{\frac{2(\ell - a)}{a_d}} = \sqrt{\frac{2(\ell - a) 2 \ell d m}{E^2 \epsilon_0 A (k - 1)}} = \sqrt{\frac{4 m \ell d (\ell - a)}{\epsilon_0 A E^2 (k - 1)}}$$

$$\therefore \text{Time period} = 2t = \sqrt{\frac{8 m \ell d (\ell - a)}{\epsilon_0 A E^2 (k - 1)}}$$

