

ELECTROCHEMISTRY

- Electrochemistry deals with the study of electrical properties of solutions of electrolytes and with the interrelation of chemical phenomenon and electrical energies. Electrical energy is carried through matter in the form of electric current with the help of suitable source and charge carriers (ions or electrons).

1. CONDUCTORS AND NON CONDUCTORS :

Substances are divided into two classes

- (a) Non conductor or insulator (b) Conductor

(a) Non - conductor :

Substances which do not allow electric current to pass through them are called non-conductors or insulators examples - pure water, ice, glass, rubber etc.

- (b) **Conductor** : Substances which allow electric current to flow through them are called conductors. Examples - Metals, Aqueous solution of acids, bases and salts, fused salts and impure water etc.

Conductors are of two types :

- (i) Metallic conductors (ii) Electrolytic conductors or electrolytes.

(i) Metallic conductors :

The conductors which conduct electric current by movement of electrons without undergoing any chemical change are known as metallic conductors.

Metals (Cu,Ag,Fe,Al etc), non metals (graphite) and various alloys and minerals are examples.

(ii) Electrolytic conductors :

Those substances whose water solution conducts the electric current and which are decomposed by the passage of current are called electrolytes. In this case, conduction takes place by movement of ions.

electrolytes also conduct electricity in fused state and undergo decomposition by passage the electric current.

u Substances whose aqueous solution does not conduct electric current are called non-electrolytes.

They do not conduct electricity in the fused state also. Solutions of cane sugar, glycerine, glucose, urea etc. are the examples of non electrolytes.

Strong electrolyte :

Electrolytes which are completely ionized in aqueous solution or in their molten state, are called strong electrolytes.

Example - all salts, strong acid and strong base

Weak electrolyte :

Electrolytes which are not completely ionized in aqueous solution or in their molten state, are called weak electrolytes.

Examples :- All carbonic acids (except sulphonic acid), CH_3COOH , HCN , NH_3 , amine, etc.

DIFFERENCE BETWEEN METALLIC AND ELECTROLYTIC CONDUCTION :

| | Metallic conduction | Electrolytic conduction |
|-------|--|--|
| (i) | Flow of electricity takes place without the decomposition of the substance | Flow of electricity takes place by chemical changes at electrodes. |
| (ii) | No transfer of matter takes place. | Transfer of matter takes place in the form of ions |
| (iii) | The resistance to the flow of current increases with the increase in temperature and hence the increase in temperature decreases the conduction. | The resistance to the flow of current decreases with the increase in temperature and hence increase in temperature increases the conduction. |

2. ELECTROLYSIS :

The process of decomposition of an electrolyte by the passage of electricity is called electrolysis or electrolytic dissociation. It is carried out in electrolytic cell where electrical energy is converted into chemical energy. For electrolysis to take place two suitable electrodes are immersed in the liquid. The solution of an electrolyte contains ions. When an electric potential is applied between the electrodes, the positively charged ions move towards the cathode and negatively ions move towards the anode, when a cation reaches the cathode, it takes up electron(s) and thus gets its charge neutralised. Thus the gain of electrons (decrease in oxidation number) means reduction takes place at the cathode.

Similarly an anion when it reaches the anode, gives up electron(s) and thus gets discharged. Loss of electrons (Increase in oxidation number) means oxidation takes place at anode.

- ◆ The tendency of an electrode to lose electrons is known as the oxidation potential.
- ◆ The tendency of an electrode to gain electrons is known as the reduction potential.

(a) Electrolysis of fused sodium chloride :

When fused sodium chloride is electrolysed, Na^+ ions move towards the cathode and Cl^- ions move towards the anode. At cathode Na^+ ions accept electrons to form sodium metal. At anode each Cl^- ion loses an electron to form Cl_2 gas.

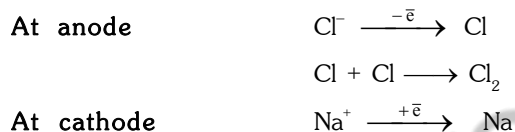

(b) Electrolysis of aqueous solution of NaCl

The solution of NaCl contains Na^+ , Cl^- and small amounts of H^+ , OH^- (due to small dissociation of water)

- ◆ If more than one type of ions are present at a given electrode, then the one ion is the one which is liberated which requires least energy. The energy required to liberate an ion is provided by the applied potential between electrodes. This potential is called discharge or deposition potential.

□ ORDER OF DISCHARGE POTENTIAL :

Higher be the discharge potential, lower will be the tendency of ion to get discharged at the respective electrode. The decreasing order of discharge potential or increasing order of deposition of some of ions are given below :

For cations : K^+ , Na^+ , Ca^{2+} , Mg^{2+} , Al^{3+} , Zn^{2+} , H^+ , Cu^+ , Ag^{2+} , Ag^+

For anions : SO_4^{2-} , NO_3^- , OH^- , Cl^- , Br^- , I^-

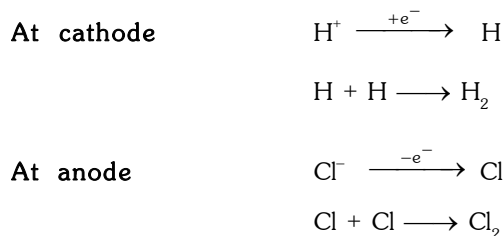

Na^+ ions move towards the cathode and combine with OH^- ions furnished by feebly ionised water to form NaOH.

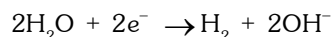

PRODUCTS OF ELECTROLYSIS OF SOME ELECTROLYTES

| S. No. | Electrolyte | Electrode | Product obtained at anode | Product obtained at cathode |
|--------|---------------------------------------|----------------|---------------------------|-----------------------------|
| (i) | Aqueous NaCl | Pt or Graphite | Cl ₂ | H ₂ |
| (ii) | Fused NaCl | Pt or Graphite | Cl ₂ | Na |
| (iii) | Aqueous NaOH | Pt or Graphite | O ₂ | H ₂ |
| (iv) | Fused NaOH | Pt or Graphite | O ₂ | Na |
| (v) | Aqueous CuSO ₄ | Pt or Graphite | O ₂ | Cu |
| (vi) | Dilute HCl | Pt or Graphite | Cl ₂ | H ₂ |
| (vii) | Dilute H ₂ SO ₄ | Pt or Graphite | O ₂ | H ₂ |
| (viii) | Aqueous AgNO ₃ | Pt or Graphite | O ₂ | Ag |

3. ELECTROLYTIC CONDUCTANCE :

- (a) **Resistance (R)** : Metallic and electrolytic conductors obey ohm's law according to which the resistance of a conductor is the ratio of the applied potential difference (V) to the current following(I).

$$R = \frac{V}{I} \quad \blacklozenge \quad R \text{ is expressed in ohms.}$$

- (b) **Conductance (C)** : The conductance of a conductor is equal to reciprocal of resistance

$$C = \frac{1}{R} \quad \blacklozenge \quad C \text{ is expressed in mho.}$$

- (c) **Specific resistance (ρ)** : The resistance (R) of a conductor of uniform cross section is directly proportional to its length(ℓ) and inversely proportional to its area of cross section (A)

$$R \propto \frac{\ell}{A} \quad R = \rho \frac{\ell}{A}$$

where ρ is a constant and called resistivity or specific resistance.

When $\ell = 1$, $A = 1$, then $\rho = R$ thus the specific resistance may be defined as the resistance of a conductor of unit length and unit area of cross section.

◆ Unit of $\rho \rightarrow$ ohm .cm

- (d) **Specific conductance (κ)** :

It is defined as the reciprocal of specific resistance

$$\kappa = \frac{1}{\rho}$$

The above definitions apply to metallic conductors and electrolytes.

◆ In the case of solution of electrolytes, the resistance offered by the solution to the flow of current is -

- (a) Directly proportional to the distance between the electrodes

$$R \propto \ell$$

- (b) Inversely proportional to the area of cross section of the electrodes

$$R \propto \frac{1}{A} \quad R = \rho \frac{\ell}{A}$$

The conductance $C = \frac{A}{\rho \ell}$

$$\therefore \frac{1}{\rho} = \kappa \quad \text{so } \kappa = \frac{C \ell}{A}$$

If $\ell = 1$ cm and $A = 1$ cm² then

$$\kappa = C$$

Hence specific conductivity of a solution is defined as the conductance of one centimeter cube of the solution of the electrolyte.

$$\diamond \quad \kappa = \frac{C\ell}{A}$$

Where $\frac{\ell}{A}$ = cell constant

- Cell constant (x) is a fixed quantity for a particular cell and is defined as the distance between two parallel electrodes of a cell divided by the area of cross section of the electrodes.

$$\kappa = C \quad \text{cell constant}$$

$$\text{cell constant} = \frac{\kappa}{C} = \kappa R = \text{Specific conductivity} \quad \text{resistance}$$

- Unit of $\kappa \rightarrow \text{ohm}^{-1} \text{cm}^{-1}$

(e) **Equivalent Conductance (λ_{eq})** : It is defined as the product of specific conductance (κ) and the volume (V in mL) of the solution which contain one gram equivalent of the electrolyte.

$$\therefore \lambda_{\text{eq}} = \kappa \quad V$$

If concentration of solution is C - gram equivalent per litre then $\lambda_{\text{eq}} = \frac{\kappa \times 1000}{C}$

- Unit $\rightarrow \text{ohm}^{-1} \text{cm}^2$ per gram equivalent

Ex : The resistance of a 1N solution of salt is 50Ω . Calculate the equivalent conductance of the solution, if the two platinum electrodes in solution are 2.1cm apart and each having an area of 4.2cm^2 .

$$\begin{aligned} \text{Sol :} \quad \kappa &= \frac{1}{\rho} = \frac{1}{R} \left(\frac{\ell}{A} \right) \\ &= \frac{1}{50} \times \frac{2.1}{4.2} = \frac{1}{100} \end{aligned}$$

$$\text{and} \quad \lambda_{\text{eq.}} = \frac{\kappa \times 1000}{N} = \frac{1}{100} \times \frac{1000}{1} = 10$$

(f) **Molar conductance : (λ_m or μ)**

It is defined as the product of specific conductance (κ) and the volume (V in mL) in which contains one mole of the electrolyte.

$$\lambda_m = \mu = \kappa \quad v$$

$$\text{and} \quad \lambda_m = \frac{\kappa \times 1000}{M}$$

Unit $\rightarrow \text{ohm}^{-1} \text{cm}^2$ per mole

Ex : Which of the following have maximum molar conductivity.

- 0.08M solution and its specific conductivity is $2 \times 10^{-2} \Omega^{-1} \text{cm}^{-1}$.
- 0.1M solution and its resistivity is $50 \Omega \text{cm}$.

$$\text{Sol : (i)} \quad \lambda_M = \frac{\kappa \times 1000}{M} = 2 \times 10^{-2} \times \frac{1000}{0.08} = 250 \Omega^{-1} \text{cm}^2 \text{mol}^{-1}$$

$$\text{(ii)} \quad \lambda_M = \frac{\kappa \times 1000}{M}$$

$$\therefore \kappa = \frac{1}{\rho}$$

$$\therefore \lambda_M = \frac{1}{50} \times \frac{1000}{0.1} = 200 \Omega^{-1} \text{cm}^2 \text{mol}^{-1}$$

So, the molar conductivity of 0.08M solution will be greater than 0.1M solution.

◆ **Relation between $\lambda_{eq.}$ and λ_M :**

$$\lambda_M = \frac{\kappa \times 1000}{M} \quad \text{and} \quad \lambda_{eq.} = \frac{\kappa \times 1000}{N}$$

We know that

$$\text{Normality} = \text{Valency Factor} \times \text{Molarity}$$

$$\text{or} \quad N = n \times M \quad \text{so} \quad \lambda_{eq.} = \frac{\lambda_M}{V.F.}$$

4. FACTORS INFLUENCING THE CONDUCTIVITY OF ELECTROLYTES :

(a) Inter ionic attraction :

If inter ionic attraction between solute is more, then the conductivity will be less.

(b) Polarity of solvent :

If the solvent is greater polarized then the ionization and conductivity will be more.

(c) Viscosity of medium :

By increasing the viscosity of medium, the conductivity decreases.

(d) Temperature :

As the temperature of electrolyte solution is increased, the conductivity increases because K.E. of ions increases and all type of attraction forces decreases and the viscosity of medium decreases.

(e) Dilution :

(i) The degree of ionisation increases with the increase of dilution of the solution the conductivity is increases due to increasing the number of ions.

(ii) Effect of dilution on specific conductance :

Specific conductance decreases with the increase of dilution of the solution due to the presence of no. of ions in 1cm^3 solution decreases.

(iii) Effect of dilution on equivalent/molar conductivity :

The equivalent/molar conductivity increases with dilution. This is due to the fact that degree of ionisation increases with dilution.

◆ When the whole of the electrolyte has ionised, further addition of the water bring a small change in the value of equivalent/molar conductance. This stage is called infinite dilution.

◆ The ratio of equivalent conductivity at any dilution to equivalent conductivity at infinite dilution is called conductivity ratio or degree of dissociation of solute -

$$\alpha = \frac{\lambda}{\lambda_{\infty}}$$

Ex : The equivalent conductivity of H_2SO_4 at infinite dilution is $384 \Omega^{-1} \text{cm}^2 \text{eq}^{-1}$. If 49 g H_2SO_4 per litre is present in solution and specific resistance is 18.4Ω then calculate the degree of dissociation.

Sol : Equivalent of $\text{H}_2\text{SO}_4 = \frac{49}{49} = 1\text{N}$

$$\text{specific conductance} = \frac{1}{\text{specific resistance}} = \frac{1}{18.4} \Rightarrow \lambda_{eq.} = \frac{1000 \times \kappa}{N} = \frac{1000 \times 1}{18.4} = 55$$

$$\text{Degree of dissociation } (\alpha) = \frac{\lambda_{eq.}^c}{\lambda_{eq.}^{\infty}} = \frac{55}{384} = 0.14 \Rightarrow \alpha \% = 14\%$$

5. KOHLRAUSCH LAW :

This law states that the equivalent conductivity of any electrolyte at infinite dilution ($\lambda_{\text{eq}}^{\infty}$) is the sum of ionic conductances of the cation and anion given by the electrolytes at infinite dilution.

$$\lambda_{\text{eq}}^{\infty} = \lambda_{\text{a}}^{\infty} + \lambda_{\text{c}}^{\infty}$$

consider a salt NaCl, its equivalent conductivity at infinite dilution is the sum of two terms i.e.

$$\lambda_{\text{eq}}^{\infty} = \lambda_{\text{Na}^+}^{\infty} + \lambda_{\text{Cl}^-}^{\infty}$$

These terms are known as ionic mobilities of anion and cation.

For A_xB_y type solution :-

$$\lambda_{\text{eq}}^{\infty} = \frac{1}{Z^+} \lambda_{\text{c}}^{\infty} + \frac{1}{Z^-} \lambda_{\text{a}}^{\infty}$$

here c = cation & a = anion and Z^+ , Z^- are the charges on the cation and anion respectively.

Ex : At infinite dilution the equivalent conductance of Al^{+3} and SO_4^{-2} ion are 189 and 160 $\Omega^{-1} \text{ cm}^2 \text{ eq}^{-1}$ respectively. Calculate the equivalent and molar conductivity at infinite dilute of $\text{Al}_2(\text{SO}_4)_3$.

Sol :
$$\lambda_{\text{eq}}^{\infty}[\text{Al}_2(\text{SO}_4)_3] = \frac{1}{3} \lambda_{\text{Al}^{+3}}^{\infty} + \frac{1}{2} \lambda_{\text{SO}_4^{-2}}^{\infty}$$

$$= \frac{1}{3} \times 189 + \frac{1}{2} \times 160 = 143 \Omega^{-1} \text{ cm}^2 \text{ eq}^{-1}$$

Molar conductivity = λ_{eq} V. F. = 143 \times 6 = 858 $\Omega^{-1} \text{ cm}^2 \text{ mol}^{-1}$

Application : This law can be used to

- Determine the equivalent conductivities of weak electrolytes at infinite dilution.
- Determination of degree of dissociation, since α , the degree of dissociation of an electrolyte at the dilution V is

given by $\alpha = \frac{\lambda}{\lambda_{\infty}}$ where $\lambda_{\infty} = \lambda_{\text{a}}^{\infty} + \lambda_{\text{c}}^{\infty}$

6. FARADAY'S LAWS OF ELECTROLYSIS :

Michael Faraday deduced two important law :

(a) Faraday's first law of electrolysis :

This law states that "The amount of a substance deposited or dissolved at an electrode is directly proportional to the charge passing through the electrolytes.

If a current of I amperes is passed for t seconds, the quantity of charge Q in coulombs. If W, gram of substances is deposited by Q coulombs of electricity, then

$$W \propto Q \propto It$$

$$W = Z It = \frac{E}{96500} It$$

Where Z is constant of proportionality and is known as electrochemical equivalent.

◆ When Q = 1 coulomb, W = Z

thus electro chemical equivalent may be defined as the weight in grams of an element liberated by the passage of 1 coulomb of electricity.

Ex : How many cc of chlorine will be deposited by 100 amp. current flowing for 5 hours through melted NaCl.

Sol : $Q = It = 100 \times 5 \times 60 \times 60 = 18 \times 10^5$

$$W = ZQ = \frac{E}{96500} \times 18 \times 10^5 = \frac{18E}{96500} \times 10^5 = \frac{18 \times 35.5}{965} \times 10^3 = 662.2 \text{ g}$$

∴ Volume of 71 g Cl_2 at NTP = 22.4 L

∴ volume of 662.2 g Cl_2 at NTP = $\frac{22.4}{71} \times 662.2 = 208.9 \text{ L}$

Ex : The time required to coat a metal surface of 80 cm^2 with 0.005mm thick layer of silver (density = 10.5 g cm^{-3}) with the passage of 3A current through silver nitrate solution is -

Sol : \therefore Volume of layer of silver = $0.005 \times 10^{-1} \times 80 = 0.04 \text{ cm}^3$
 \therefore Mass = Density \times volume = $10.5 \times 0.04 = 0.42 \text{ g}$

$$\text{So } w = \frac{E}{96500} \text{ It} \Rightarrow 0.42 = \frac{108}{96500} \times 3 \times t$$

$$t = \frac{0.42 \times 96500}{108 \times 3} = 125.09 \text{ seconds.}$$

(b) Faraday's second law : This law states that the amounts of different substances deposited at electrodes by passage of the same quantity of electricity are proportional to their chemical equivalent(E).

$$W \propto E$$

If W_1 and W_2 be the amounts of two different substances deposited at electrodes and E_1 and E_2 be the equivalent weights then -

$$\frac{W_1}{W_2} = \frac{E_1}{E_2}$$

combining the two laws

$$W \propto \text{ItE} \quad W = \frac{\text{ItE}}{F} \quad \text{Where } \frac{1}{F} \text{ is proportionality constant and } F \text{ is called faraday.}$$

when $\text{It} = F$ then $W = E$

Hence faraday (F) is the quantity of charge in coulombs required to deposit one g equivalent of any substance.

◆ The Faraday (F) is also the quantity of charge carried by one mole of electrons.

$$F = e \times N = 1.6 \times 10^{-19} \times 6.023 \times 10^{23} = 96500 \text{ coulombs.}$$

Ex : The same current is passed through solution of silver nitrate and cupric salt connected in series. If the weight of silver deposited is 1.08 g . Calculate the weight of copper deposited

Sol : According to faradays second law

$$\frac{W_1}{W_2} = \frac{E_1}{E_2} \Rightarrow \frac{1.08}{W_2} = \frac{108}{31.75} \Rightarrow W_2 = 0.3175 \text{ g}$$

7. ELECTRO CHEMICAL CELL/GALVANIC CELL/ VOLTAIC CELL :

Example - Daniel Cell

- ◆ A cell in which the chemical energy is transformed into electrical energy.
- ◆ The chemical reaction occurring in a galvanic cell is always a redox reaction.
- ◆ During the chemical process, the reduction in free energy will obtain as a result in the form of electrical energy.

Galvanic cell is made up of two half cells i.e., anodic and cathodic. The cell reaction is of redox kind. Oxidation takes place at anode and reduction at cathode. It is also known as **voltaic cell**. It may be represented as shown in fig. Zinc rod immersed in ZnSO_4 behaves as anode and copper rod immersed in CuSO_4 behaves as cathode.

Oxidation takes place at anode :



Reduction takes place at cathode :

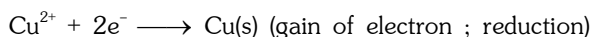

Over all process :

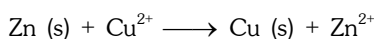

In galvanic cell like Daniell cell ; electrons flow from anode (zinc rod) to the cathode (copper rod) through external circuit ; zinc dissolves as Zn^{2+} ; Cu^{2+} ion in the cathode cell picks up two electron and become deposited at cathode.

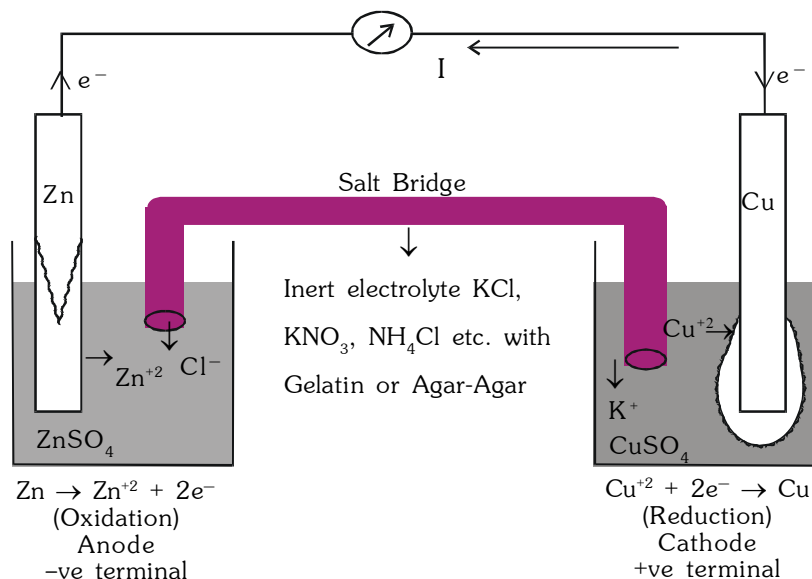

◆ **Salt bridge :**

1. It allows to flow of current by completing the circuit.
2. It maintains electrical neutrality of electrolytes in two half cells.

◆ **Characteristics of electrolyte used in salt bridge :**

1. The electrolyte should be inert
2. The cations and anions of the electrolyte used should be of the same ionic mobility.

□ **ELECTROLYTIC CELL :**

This cell converts electric energy into chemical energy. The entire assembly except that of the external battery is known as the electrolytic cell.

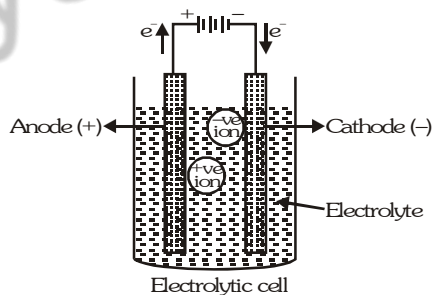

Cell reaction :

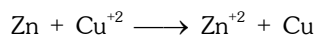

Representation of Galvanic cell.

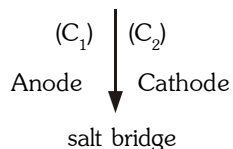

□ **REPRESENTATION OF ELECTROCHEMICAL CELL :**

Ex : (i) Zn (s) | Zn²⁺ (aq) || Cu²⁺ (aq.) / Cu (s)

(ii) Pt/H₂ (g) (1 atm)|H⁺ (aq) || Cu²⁺ (aq.) | Cu (s).

1. First of all, the anode is written.
2. After anode, the electrolyte of the anode should be written with its concentration in the bracket.
3. A slash (/) is put between anode and electrolyte to denote the surface barrier between the two as they exist in different phases.
4. Then we denote salt bridge by two vertical parallel lines. (||).
5. Then, we write the electrolyte of cathode (negative electrode) followed by its concentration in bracket.
6. Finally, after a slash, we write the cathode.
7. In case of gas, the gas is to be indicated after the electrode in case of anode and before the electrode in case of cathode.

Ex. Pt, H₂/H⁺ or H⁺ / H₂, Pt

◆ **Electrode potential :**

When a strip of metal is brought in contact with the solution containing its own ions then the strip of metal gets positively charged or negatively charged and results into a potential being developed between the metallic strip and its solution which is known as electrode potential.

At anode

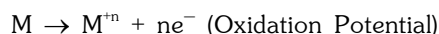

At cathode

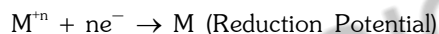

◆ The value of electrode potential depends upon :

- (1) the nature of electrode
- (2) the concentration of solution
- (3) the temperature

◆ **Standard electrode potential (E⁰) :**

If the concentration of ions is unity, temperature is 25 C and pressure is 1 atm (standard conditions), the potential of the electrode is called standard electrode potential.

- ◆ The given value of electrode potential be regarded as reduction potential unless it is specifically mentioned that it is an oxidation potential.

◆ **Electro motive force of cell or cell voltage :**

The difference in the electrode potentials of the two electrodes of the cell is termed as electro motive force [EMF] or cell voltage.

$$E_{\text{cell}} = E_{\text{red}} \text{ (cathode) } - E_{\text{red}} \text{ (anode)}$$

or
$$E_{\text{cell}} = E_{\text{oxi.}} \text{ (anode) } - E_{\text{oxi.}} \text{ (Cathode)}$$

or
$$E_{\text{cell}} = E_{\text{oxi.}} \text{ (anode) } + E_{\text{red}} \text{ (cathode)}$$

8. ELECTRO CHEMICAL SERIES :

Standard Aqueous Electrode potentials at 298K

'THE ELECTROCHEMICAL SERIES'

| Element | Electrode Reduction Reaction | Standard electrode Reduction potential E^0 , Volts |
|---------------|--|--|
| Li | $\text{Li}^+ + e^- \rightarrow \text{Li}$ | - 3.05 |
| K | $\text{K}^+ + e^- \rightarrow \text{K}$ | - 2.93 |
| Ba | $\text{Ba}^{+2} + 2e^- \rightarrow \text{Ba}$ | - 2.90 |
| Ca | $\text{Ca}^{+2} + 2e^- \rightarrow \text{Ca}$ | - 2.87 |
| Na | $\text{Na}^+ + e^- \rightarrow \text{Na}$ | - 2.71 |
| Mg | $\text{Mg}^{+2} + 2e^- \rightarrow \text{Mg}$ | - 2.37 |
| Al | $\text{Al}^{+3} + 3e^- \rightarrow \text{Al}$ | - 1.66 |
| Mn | $\text{Mn}^{+2} + 2e^- \rightarrow \text{Mn}$ | - 1.18 |
| Zn | $\text{Zn}^{+2} + 2e^- \rightarrow \text{Zn}$ | - 0.76 |
| Cr | $\text{Cr}^{+3} + 3e^- \rightarrow \text{Cr}$ | - 0.74 |
| Fe | $\text{Fe}^{+2} + 2e^- \rightarrow \text{Fe}$ | - 0.44 |
| Cd | $\text{Cd}^{+2} + 2e^- \rightarrow \text{Cd}$ | - 0.40 |
| Ni | $\text{Ni}^{+2} + 2e^- \rightarrow \text{Ni}$ | - 0.25 |
| Sn | $\text{Sn}^{+2} + 2e^- \rightarrow \text{Sn}$ | - 0.14 |
| Pb | $\text{Pb}^{+2} + 2e^- \rightarrow \text{Pb}$ | - 0.13 |
| H_2 | $2\text{H}^+ + 2e^- \rightarrow \text{H}_2$ | 0 |
| Cu | $\text{Cu}^{+2} + 2e^- \rightarrow \text{Cu}$ | + 0.34 |
| I_2 | $\text{I}_2 + 2e^- \rightarrow 2\text{I}^-$ | + 0.54 |
| Hg | $\text{Hg}_2^{+2} + 2e^- \rightarrow 2\text{Hg}$ | + 0.79 |
| Ag | $\text{Ag}^+ + e^- \rightarrow \text{Ag}$ | + 0.80 |
| Hg | $\text{Hg}^{+2} + 2e^- \rightarrow \text{Hg}$ | + 0.85 |
| Br_2 | $\text{Br}_2 + 2e^- \rightarrow 2\text{Br}^-$ | + 1.08 |
| Cl_2 | $\text{Cl}_2 + 2e^- \rightarrow 2\text{Cl}^-$ | + 1.36 |
| Pt | $\text{Pt}^{+2} + 2e^- \rightarrow \text{Pt}$ | + 1.20 |
| Au | $\text{Au}^{+3} + 3e^- \rightarrow \text{Au}$ | + 1.50 |
| F_2 | $\text{F}_2 + 2e^- \rightarrow 2\text{F}^-$ | + 2.87 |

□ **IMPORTANT POINTS ABOUT SERIES :**

1. Electrode whose standard reduction potential (SRP) is less, act as anode, and other one which has high reduction potential acts as cathode.
2. Metals near the top of the series are strongly electropositive.
3. Metals near the top of the series can displace more electronegative metal below them from their salt.

For example :

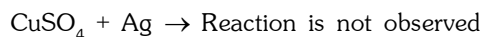
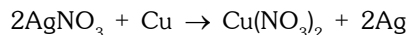

4. Metal above hydrogen can displace H_2 from dilute acid

For example -

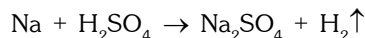

5. Hydroxides of metal in the upper part of series are strongly basic while hydroxides of a metal in lower part are weakly basic.
6. The activity of non metals increases from top to bottom.
7. The metals which come below copper, form unstable oxides i.e., these are decomposed on heating.

9. NERNST EQUATION :

With the help of Nernst equation, we can calculate the electrode potential of electrode or EMF of cell.

$$E_{\text{cell}} = E^0 - \frac{RT}{nF} \log_e \frac{[\text{Product}]}{[\text{Reactant}]}$$

Where - E^0 = standard electrode potential

R = gas constant

T = temperature (in K)

F = Faraday (96500 coulomb mol^{-1})

n = no. of e^- gained or loosed in balanced equation.

or
$$E_{\text{cell}} = E^0 - \frac{0.0591}{n} \log_{10} \frac{[\text{Product}]}{[\text{Reactant}]} = E - \frac{0.0591}{n} \log Q$$

Let, in the cell :

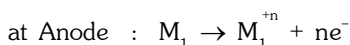

for this reaction -

$$E_{\text{oxi}} = E_{\text{oxi}}^0 - \frac{0.0591}{n} \log_{10} \frac{[\text{M}_1^{+n}]}{[\text{M}_1]} \quad \dots(1)$$

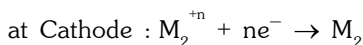

for this reaction -

$$E_{\text{red.}} = E_{\text{red.}}^0 - \frac{0.0591}{n} \log_{10} \frac{[\text{M}_2]}{[\text{M}_2^{+n}]} \quad \dots(2)$$

Note : Concentration of solid taken as unity.

so $[\text{M}_1] = [\text{M}_2] = 1$

We know that EMF of cell is

$$\text{EMF} = E_{\text{oxi}} + E_{\text{red.}}$$

(Anode) (Cathode)

By adding equation (1) & (2) we get :

$$\begin{aligned} \text{EMF} &= E_{\text{oxi}}^0 - \frac{0.0591}{n} \log [M_1^{+n}] + E_{\text{red.}}^0 - \frac{0.0591}{n} \log \frac{1}{[M_2^{+n}]} \\ &= (E_{\text{oxi}}^0 + E_{\text{red.}}^0) - \frac{0.0591}{n} [\log [M_1^{+n}] - \log [M_2^{+n}]] \\ \text{EMF} &= E_{\text{cell}} = E_{\text{cell}}^0 - \frac{0.0591}{n} \log \frac{[M_1^{+n}]}{[M_2^{+n}]} \end{aligned}$$

Ex : The 0.1M copper sulphate solution in which copper electrode is dipped at 25 C. Calculate the electrode potential of copper electrode [Given $E^0 \text{ Cu}^{+2} / \text{Cu} = 0.34\text{V}$]

Sol : $\text{Cu}^{+2} + 2e^- \rightarrow \text{Cu}$

$$E_{\text{red}} = E_{\text{red}}^0 - \frac{0.0591}{n} \log \frac{[\text{Product}]}{[\text{Reactant}]}$$

here $n = 2$

$$\begin{aligned} \text{so } E &= 0.34 - \frac{0.0591}{2} \log 10 \\ &= 0.34 - 0.03 = 0.31 \text{ Volts} \end{aligned}$$

Ex : The EMF of the cell

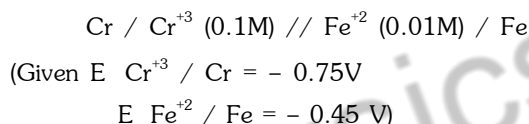

Sol : Half cell reactions are :

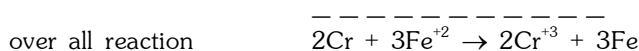

$$\begin{aligned} E_{\text{cell}} &= \text{oxidation pot.} + \text{Reduction pot.} \\ &= 0.75 + (-0.45) = 0.30 \end{aligned}$$

$$E_{\text{cell}} = E^0 - \frac{0.0591}{n} \log \frac{[\text{Product}]}{[\text{Reactant}]}$$

$$= 0.30 - \frac{0.0591}{6} \log \frac{[\text{Cr}^{+3}]^2}{[\text{Fe}^{+2}]^3} = 0.30 - \frac{0.0591}{6} \log \frac{[0.1]^2}{[0.01]^3} = 0.30 - \frac{0.24}{6} = 0.26 \text{ Volt.}$$

□ DIFFERENT TYPES OF ELECTRODES :

1. Metal - Metal ion electrode M/M^{n+}

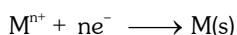

$$E = E^0 + \frac{0.0591}{n} \log [M^{n+}]$$

2. Gas - ion Electrode



as a reduction electrode

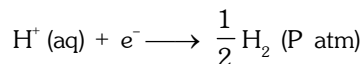

$$E = E^\circ - 0.0591 \log \frac{P_{\text{H}_2}^{\frac{1}{2}}}{[\text{H}^+]}$$

3. Oxidation - reduction Electrode

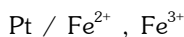

as a reduction electrode

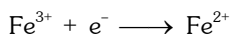

$$E = E^\circ - 0.0591 \log \frac{[\text{Fe}^{2+}]}{[\text{Fe}^{3+}]}$$

4. Metal - Metal insoluble salt electrode



as a reduction electrode

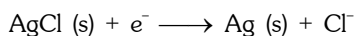

$$E_{\text{Cl}^-/\text{AgCl}/\text{Ag}} = E_{\text{Cl}^-/\text{AgCl}/\text{Ag}}^\circ - 0.0591 \log [\text{Cl}^-]$$

Note :

1. The value of electrode potential does not depend on stoichiometry of half reactions.
2. In electrolytic cell, cathode is negative terminal whereas in Galvanic cell cathode is positive terminal.
3. Work obtained by electro chemical cell = -free energy of cell

$$\Delta G = -nFE_{\text{cell}} \quad \Delta G = -nFE_{\text{cell}}$$

4. Cell reaction is spontaneous, if

$$\Delta G = -ve \quad \text{or} \quad E_{\text{cell}} = +ve$$

5. Cell reaction will be in equilibrium

$$\text{Ex.} \quad \Delta G = 0 \quad \text{or} \quad -nFE_{\text{cell}} = 0 \quad \text{or} \quad E_{\text{cell}} = 0$$

6. In nernst equation

$$E_{\text{cell}} = E_{\text{cell}}^\circ - \frac{0.0591}{n} \log_{10} \frac{[\text{Product}]}{[\text{Reactant}]}$$

If $E_{\text{cell}} = 0$, then

$$E_{\text{cell}}^\circ = \frac{0.0591}{n} \log_{10} \frac{[\text{Product}]}{[\text{Reactant}]}$$

$$\text{or} \quad E_{\text{cell}}^\circ = \frac{0.0591}{n} \log_{10} K \quad \text{or} \quad E_{\text{cell}}^\circ = \frac{RT}{nF} \log_e K$$

put the value of E_{cell}° in

$$\Delta G = -nFE_{\text{cell}}$$

$$\text{we get} \quad \Delta G^\circ = -nF \frac{RT}{nF} \log_e K \Rightarrow \Delta G^\circ = -RT \log_e K$$

☐ **Reference Electrode :**

An electrode used to calculate the electrode potential of other electrodes.

(a) **Standard Hydrogen Electrode (SHE) :**

It consist of a platinum electrode over which H_2 gas (1 atm pressure) is bubbled and the electrode is immersed in a solution that is 1 M in H^+ at 25 C.

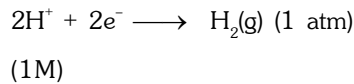

the potential of this electrode at 25 C is taken as Zero volt.

(b) **Calomel Electrode :**

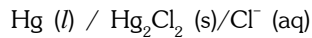

It is prepared by a Pt wire in contact with a paste of Hg and Hg_2Cl_2 present in a KCl solution.

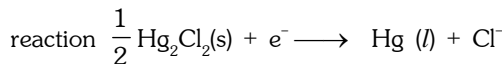

$$E = E^\circ - 0.0591 \log [Cl^-].$$

☐ **Heat of Reaction inside the cell :** Let n Faraday charge flows out of a cell of e.m.f. E, then

$$-\Delta G = nFE \quad \dots\dots(i)$$

Gibbs Helmholtz equation (from thermodynamics) may be given as,

$$\Delta G = \Delta H + T \left[\frac{\partial \Delta G}{\partial T} \right]_p \quad \dots\dots(ii)$$

From Eqs. (i) and (ii), we have

$$-nFE = \Delta H + T \left[\frac{\partial(-nFE)}{\partial T} \right]_p = \Delta H - nFT \left[\frac{\partial E}{\partial T} \right]_p$$

$$\therefore \Delta H = -nFE + nFT \left[\frac{\partial E}{\partial T} \right]_p$$

☐ **Entropy change inside the cell :**

We known that $G = H - TS$ or $\Delta G = \Delta H - T\Delta S$... (i)

where ΔG = Free energy change , ΔH = Enthalpy change and ΔS = entropy change.

According to Gibbs Helmholtz equation,

$$\Delta G = \Delta H + T \left[\frac{\partial \Delta G}{\partial T} \right]_p \quad \dots\dots(ii)$$

From Eqs. (i) and (ii), we have

$$-T\Delta S = T \left[\frac{\partial \Delta G}{\partial T} \right]_p \quad \text{or} \quad \Delta S = - \left[\frac{\partial \Delta G}{\partial T} \right]_p$$

$$\text{or} \quad \Delta S = nF \left[\frac{\partial E}{\partial T} \right]_p$$

where $\left[\frac{\partial E}{\partial T} \right]_p$ is called temperature coefficient of e.m.f. of the cell.

❑ SOME COMMERCIAL BATTERIES

Any battery or cell that we use as a source of electrical energy is basically an electrochemical cell where oxidising and reducing agents are made to react by using a suitable device. In principle, any redox reaction can be used as the basis of an electrochemical cell, but there are limitations to the use of most reactions as the basis of practical batteries. A battery should be reasonably light and compact and its voltage should not vary appreciably during the use.

There are mainly two types of cells : (i) primary cells and (ii) secondary cells. In primary cells, the reaction occurs only once and the battery then becomes dead over a period of time and cannot be used again. (For example, dry cell, mercury cell.) Contrary to this, secondary cells can be recharged by passing a current through them so that they can be used again and again. (For example, lead storage battery, nickel- cadmium storage cell.)

❑ PRIMARY CELLS

The most familiar type of battery is the dry cell which is a compact of Leclanche cell known after its discover Leclanche (fig.): In this cell, the anode consists of a zinc container and the cathode is a graphite rod surrounded by powdered MnO_2 and carbon. The space between the electrodes is filled with a moist paste of NH_4Cl and ZnCl_2 . The electrode reactions are complex, but they can be written approximately as follows.

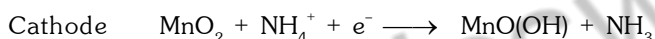
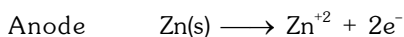

In the cathode reaction, manganese is reduced from the +4 oxidation state to the +3 state. Ammonia is not liberated as a gas but combines with Zn^{2+} to form $\text{Zn}(\text{NH}_3)_4^{2+}$ ion.

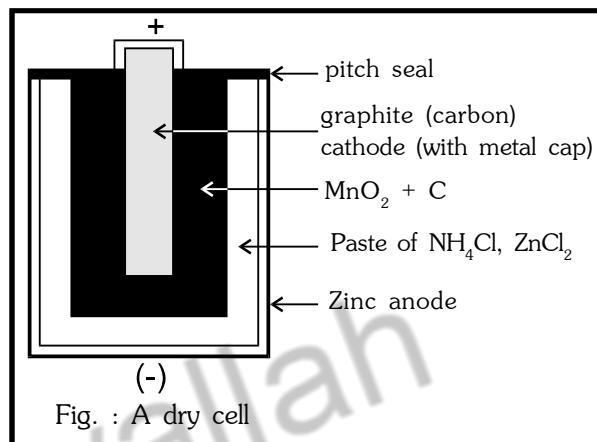

❑ SECONDARY CELLS

The most important secondary cell is the lead storage battery. It consists of a **lead anode** and a grid of lead packed with **lead dioxide as cathode**. A solution of sulphuric acid (38 percent by mass or having density 1.30 g cm^{-3}) is used as an electrolyte.

When the cell discharges, it operates as a voltaic cell. The lead is oxidised to Pb^{+2} ion and lead plates acquire a negative charge.

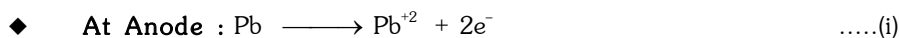
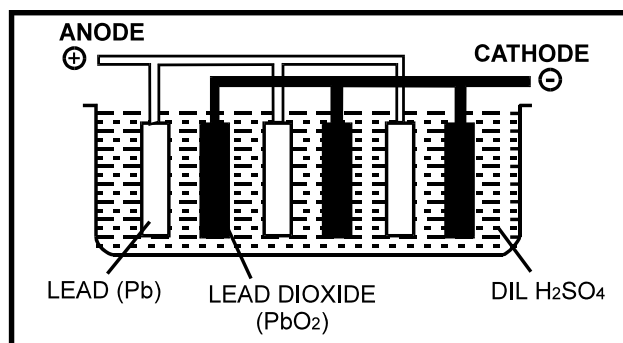

Pb^{+2} ions combine with sulphate ions of solution to form insoluble lead sulphate PbSO_4 , when begins to coat lead electrode



The electrons given by Pb are used at cathode (PbO_2 electrode)

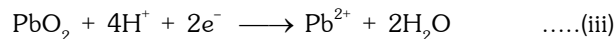

Over all cell reaction \rightarrow add equation (i), (ii), (iii) & (iv)

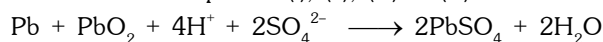

$$E_{\text{cell}} \text{ is } 2.041 \text{ volt}$$

(A 12 V lead storage battery is generally used which consist of 6 cells each producing 2 volt)

When a potential slightly greater than the potential of battery is applied, the battery can be recharged. During recharging the cell is operated like an electrolytic cell i.e. now electrical energy is supplied to it from an external source. The electrodes reactions are reverse of those that occur during discharge :

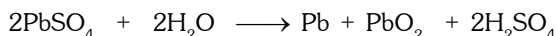

It is clear that H_2SO_4 is used up during the discharge & produced during recharging reaction of cell.

Another secondary cell is the nickel-cadmium storage cell which has a longer life than the lead storage cell but it is more expensive to manufacture.

❑ FUEL CELLS

It is possible to make batteries in which the reactants are fed continuously to the electrodes. Electrical cells that are designated to convert the free energy from the combustion of fuels such as hydrogen, carbon monoxide or methane directly into electrical energy are called FUEL CELLS. One of the most successful fuel cells uses the reaction of hydrogen with oxygen to form water (fig.). This cell has been used for electric power in the Appollo space programme. The water vapour produced was condensed and added to the drinking water supply for the astronauts.

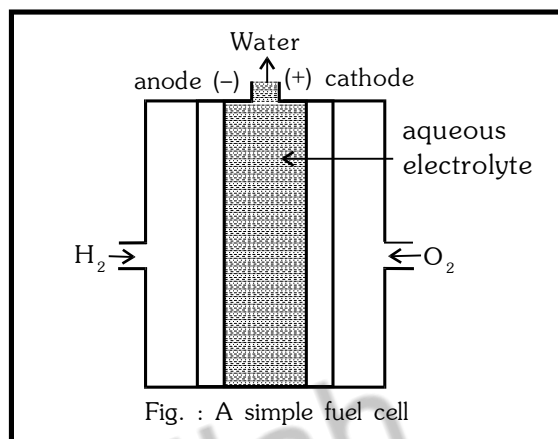

In the cell (fig.) hydrogen and oxygen are bubbled through a porous carbon electrode into concentrated aqueous sodium hydroxide. Catalysts are incorporated in the electrode. The electrode reactions are :

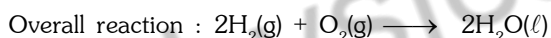
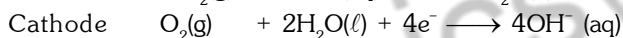
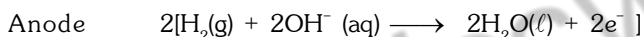

This cells runs continuously as long as the reactants are supplied.

❑ CORROSION

Corrosion is basically an electrochemical phenomenon. The rusting of iron, the tarnishing of silver, development of a green coating on copper and bronze are some of the examples of corrosion. Corrosion causes enormous damage to building, bridges, ships and to many other articles made of iron. We spend crores of rupees every year on this account.

In corrosion, a metal is oxidised by loss of electrons to oxygen and forms metal oxide. Corrosion of iron(which is commonly known as rusting) occurs in presence of water and oxygen (air).

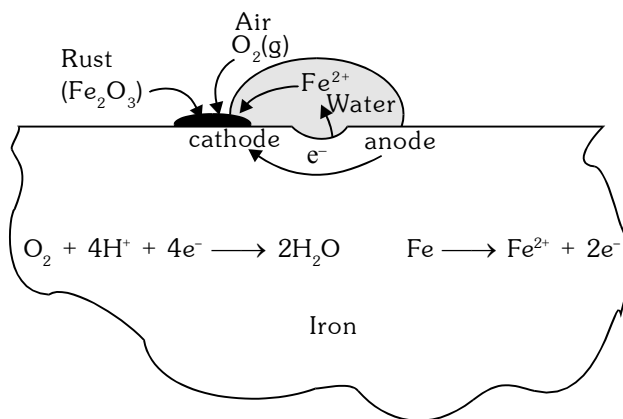
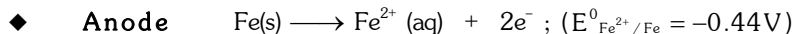
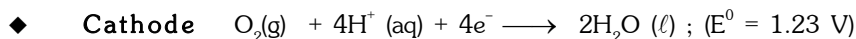

Fig. : The rusting of Iron (Iron in contact with water forms the anode and in contact with air forms the cathode. At the anode iron is oxidised to Fe^{2+} , and at the cathode oxygen is reduced to water

Although the chemistry of corrosion is complex but it is understood that at one spot of an iron object oxidation occurs and that spot behaves as an anode.



Electrons released at anode move through the metal and go to another spot on the metal and reduce the oxygen in presence of H^+ ions (which is believed to be available from H_2CO_3 formed due to dissolution of CO_2 in water). This spot works as a cathode :



Here Fe^{2+} ions move through water on the surface of the iron object. (If water present is saline, it will help more in carrying the current in the miniature cell thus formed and will enhance corrosion). The overall reaction of the miniature cell is the sum of the cathode and anode reactions as follows :

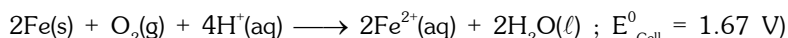

The Fe^{2+} ions are further oxidised by atmospheric oxygen to Fe^{3+} (as Fe_2O_3) and comes out as rust in the form of a hydrated iron (III) oxide expressed as $\text{Fe}_2\text{O}_3 \cdot x\text{H}_2\text{O}$.

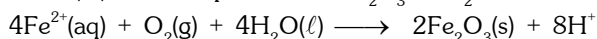

H^+ ions produced in the above reaction help further in rusting.

Impurities present in iron also enhance rusting by setting a number of miniature cells. Very pure iron does not rust quickly.

□ **PREVENTION FROM CORROSION**

Corrosion of a metal is prevented by applying protective coating (such as grease, paint or metal coatings) on its (metals) surface. In case of iron this coating is done in two ways : (i) electrolysis (Cr, Ni and Cd coating) (ii) dipping iron objects in a molten metal (Zn and Sn coating). Use of zinc coating to protect iron is called Galvanisation. In galvanising iron, zinc being more reactive than iron serves as an anode and is oxidised



Here it is important to note that iron does not rust even after zinc coating is broken which is not true in case of tin coating over iron ($E^0_{\text{Sn}^{2+}/\text{Sn}} = -0.14\text{V}$). Now if the coating is broken, iron is exposed and iron being more active than both copper and tin, is corroded. Here iron corrodes more rapidly than it does in the absence of tin. But tin protects copper in the same way as zinc protects iron ($E^0_{\text{Cu}^{2+}/\text{Cu}} = 0.34\text{V}$). Instead of coating more reactive metals on iron, the use of such metals is made as sacrificial anode. This method of preventing iron from corrosion is called CATHODIC PROTECTION. In this method, a plate of reactive metal (Zn or Mg) is buried beside the iron pipe or tank and connected to it by wires.

Here iron becomes **cathode** and more reactive metal becomes **anode**. The reactive metal anode is sacrificed to protect the iron. Since these reactive metal plates are oxidised quickly, they are replaced from time to time which is easy to do.

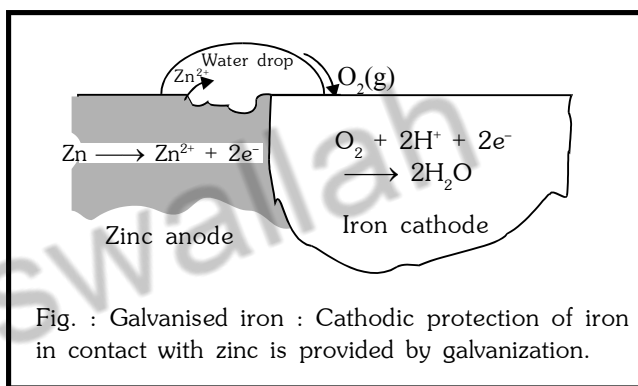

Fig. : Galvanised iron : Cathodic protection of iron in contact with zinc is provided by galvanization.

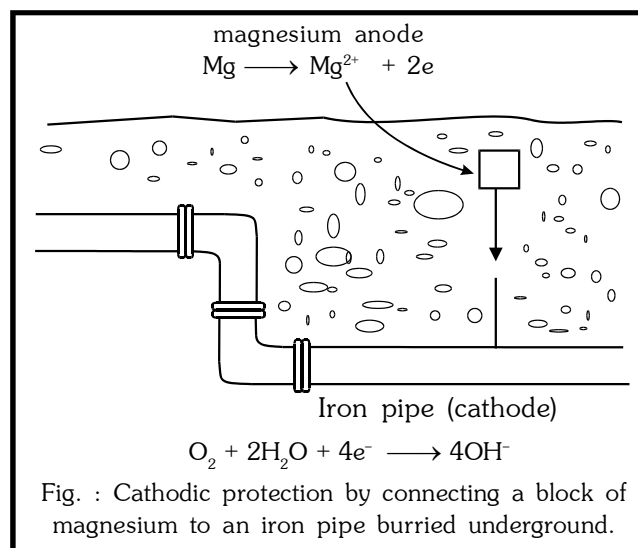

Fig. : Cathodic protection by connecting a block of magnesium to an iron pipe buried underground.

SOLVED EXAMPLES

Ex.1 How many moles of electrons are needed for the reduction of 20 mL of 0.5M solution of KMnO_4 in acid medium ?

Sol. Moles of $\text{KMnO}_4 = M \times V (\text{L}) = 0.5 \times 20 \times 10^{-3} = 10^{-2}$ [$\because \text{Mn}^{7+} + 5e^- \longrightarrow \text{Mn}^{2+}$]
 $\therefore 1 \text{ mol } \text{KMnO}_4 \text{ required} = 5 \text{ mol } e^-$
 $\therefore 10^{-2} \text{ mol } \text{KMnO}_4 \text{ required} = 5 \times 10^{-2} \text{ mol } e^-$

Ex.2 An aqueous solution of NaCl is electrolysed with inert electrodes. Write the equations for the reactions taking place at cathode and anode. What happens if $\text{NaNO}_3(\text{aq.})$ is used instead of NaCl ?

Sol. **For $\text{NaCl}_{(\text{aq.})}$** anode : $2\text{Cl}^- \longrightarrow \text{Cl}_2 + 2e^-$
cathode : $2\text{H}^+ + 2e^- \longrightarrow \text{H}_2$
For $\text{NaNO}_3(\text{aq.})$ anode : $2\text{OH}^- \longrightarrow \text{H}_2\text{O} + 1/2 \text{O}_2 + 2e^-$
cathode : $2\text{H}^+ + 2e^- \longrightarrow \text{H}_2$

Ex.3 On electrolysing CuSO_4 solution in presence of Pt, the solution becomes colourless, blue colour of solution disappears. Why ?

Sol. At cathode : $\text{Cu}^{2+} + 2e^- \longrightarrow \text{Cu}$
At anode : $2\text{OH}^- \longrightarrow \text{H}_2\text{O} + 1/2 \text{O}_2 + 2e^-$

Cu^{2+} ions are reduced and blue colour is due to Cu^{2+} .

Ex.4 Colour of KI solution containing starch turns blue when Cl_2 water is added. Explain.

Sol. Chlorine placed below iodine in electrochemical series having more reduction potential and thus shows reduction whereas I^- undergoes oxidation. The I_2 so formed get absorbed in starch to give blue colour.

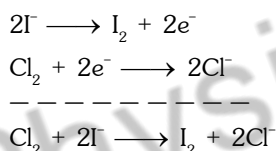

Ex.5 The resistance of a 0.01 N solution of an electrolyte was found to 210 ohm at 298 K using a conductivity cell with a cell constant of 0.88 cm^{-1} . Calculate specific conductance and equivalent conductance of solution.

Sol. Given for 0.01 N solution.

$$R = 210 \text{ ohm}$$

$$\frac{\ell}{A} = 0.88 \text{ cm}^{-1}$$

Specific conductance

$$\therefore \kappa = \frac{1}{R} \times \frac{\ell}{A}$$

$$\kappa = \frac{1}{210} \times 0.88 = 4.19 \times 10^{-3} \text{ mho cm}^{-1}$$

$$\lambda_{\text{eq}} = \frac{\kappa \times 1000}{N}$$

$$\lambda_{\text{eq}} = \frac{4.19 \times 10^{-3} \times 1000}{0.01}$$

$$\lambda_{\text{eq}} = 419 \text{ mho cm}^2 \text{ eq}^{-1}.$$

- Ex.6** The conductivity of pure water in a conductivity cell with electrodes of cross-sectional area 4 cm^2 placed at a distance 2 cm apart is $8 \times 10^{-7} \text{ S cm}^{-1}$. Calculate :
- (a) the resistance of water.
- (b) the current that would flow through the cell under the applied potential difference of 1 volt .

Sol. Cell constant = $\frac{\ell}{A} = \frac{2}{4} = \frac{1}{2} \text{ cm}^{-1}$

(a) Also $\kappa = \frac{1}{R} \times \frac{\ell}{A}$

$$R = \frac{1}{\kappa} \times \frac{\ell}{A} = \frac{1}{8 \times 10^{-7}} \times \frac{1}{2} = 6.25 \times 10^5 \text{ ohm}$$

(b) From Ohm's law, $\frac{V}{I} = R \quad \therefore I = \frac{1}{6.25 \times 10^5} = 1.6 \times 10^{-6} \text{ ampere}$

- Ex.7** The specific conductivity of a solution containing 1.0 g of anhydrous BaCl_2 in 200 cm^3 of the solution has been found to be 0.0058 S cm^{-1} . Calculate the molar and equivalent conductivity of the solution. Molecular wt. of $\text{BaCl}_2 = 208$.

Sol. Molarity of $\text{BaCl}_2 = \frac{1 \times 1000}{208 \times 200} = 0.024 \text{ M}$

Also normality of $\text{BaCl}_2 = 0.024 \times 2 = 0.048 \text{ N} (\because N = M \times V. f)$

Now $\mu = k \times \frac{1000}{C_M} = \frac{0.0058 \times 1000}{0.024} = 241.67 \text{ S cm}^2 \text{ mol}^{-1}$

Also $\lambda = k \times \frac{1000}{C_N} = \frac{0.0058 \times 1000}{0.048} = 120.83 \text{ S cm}^2 \text{ equivalent}^{-1}$

- Ex.8** The resistance of a solution 'A' is 50 ohm and that of solution 'B' is 100 ohm , both solution being taken in the same conductivity cell. If equal volumes of solutions A and B are mixed, what will be the resistance of the mixture using the same cell ?

(Assume that there is no increase in the degree of dissociation of A and B on mixing.)

- Sol.** Let k_1 and k_2 be the specific conductance of the solution A and B respectively and the cell constant of the cell be X.

For solution A : Sp. conductance = Conductance \times Cell constant

$$k_1 = \frac{1}{50} \times X \quad \dots\dots\dots (i)$$

For solution B : Sp. conductance, $k_2 = \frac{1}{100} \times X \quad \dots\dots\dots (ii)$

When equal volumes of A and B are mixed, both the solutions get doubly diluted, hence their individual contribution towards the sp. conductance of the mixture will be $\frac{k_1}{2}$ and $\frac{k_2}{2}$ respectively and the sp. conductance of the mixture will be $\frac{1}{2}(k_1 + k_2)$.

$$\therefore \text{For the mixture : } \frac{1}{2}(k_1 + k_2) = \frac{1}{R} \times X \quad \dots\dots\dots (iii)$$

(R is the resistance of mixture)

From equation (i), (ii) and (iii) ; $R = 66.67 \text{ ohm}$

Ex.9 The value of μ^∞ for NH_4Cl , NaOH and NaCl are 129.8, 248.1 and 126.4 $\text{ohm}^{-1} \text{cm}^2 \text{mol}^{-1}$ respectively. Calculate μ^∞ for NH_4OH solution.

Sol.

$$\begin{aligned}\mu_{\text{NH}_4\text{OH}}^\infty &= \mu_{\text{NH}_4\text{Cl}}^\infty + \mu_{\text{NaOH}}^\infty - \mu_{\text{NaCl}}^\infty \\ &= 129.8 + 248.1 - 126.4 \\ \mu_{\text{NH}_4\text{OH}}^\infty &= 251.5 \text{ ohm}^{-1} \text{cm}^2 \text{mol}^{-1}\end{aligned}$$

Ex.10 Calculate molar conductance for NH_4OH , given that molar conductances for Ba(OH)_2 , BaCl_2 and NH_4Cl are 523.28, 280.0 and 129.8 $\text{ohm}^{-1} \text{cm}^2 \text{mol}^{-1}$ respectively.

Sol.

$$\begin{aligned}\mu_{\text{Ba(OH)}_2}^\infty &= \lambda_{\text{Ba}^{2+}}^\infty + 2\lambda_{\text{OH}^-}^\infty = 523.28 \quad \dots\dots\dots \text{(i)} \\ \mu_{\text{BaCl}_2}^\infty &= \lambda_{\text{Ba}^{2+}}^\infty + 2\lambda_{\text{Cl}^-}^\infty = 280.00 \quad \dots\dots\dots \text{(ii)} \\ \mu_{\text{NH}_4\text{Cl}}^\infty &= \lambda_{\text{NH}_4^+}^\infty + \lambda_{\text{Cl}^-}^\infty = 129.80 \quad \dots\dots\dots \text{(iii)}\end{aligned}$$

$$\mu_{\text{NH}_4\text{OH}}^\infty = \lambda_{\text{NH}_4^+}^\infty + \lambda_{\text{OH}^-}^\infty = ?$$

Eq.(iii) + $\frac{\text{Eq.(i)}}{2} - \frac{\text{Eq.(ii)}}{2}$ will give

$$\lambda_{\text{NH}_4^+}^\infty + \lambda_{\text{OH}^-}^\infty = \lambda_{\text{NH}_4\text{OH}}^\infty = \frac{502.88}{2} = 251.44 \text{ ohm}^{-1} \text{cm}^2 \text{mol}^{-1}$$

Ex.11 The equivalent conductivities of acetic acid at 298 K at the concentrations of 0.1 M and 0.001 M are 5.20 and 49.2 $\text{S cm}^2 \text{eq.}^{-1}$ respectively. Calculate the degree of dissociation of acetic acid at these concentrations. Given that, $\lambda^\infty(\text{H}^+)$ and $\lambda^\infty(\text{CH}_3\text{COO}^-)$ are 349.8 and 40.9 $\text{ohm}^{-1} \text{cm}^2 \text{mol}^{-1}$ respectively.

Sol. Degree of dissociation is given by $\alpha = \frac{\lambda^c}{\lambda^\infty}$

(i) Evaluation of $\lambda_{\text{CH}_3\text{COOH}}^\infty$

$$\begin{aligned}\lambda_{\text{CH}_3\text{COOH}}^\infty &= \lambda_{\text{CH}_3\text{COO}^-}^\infty + \lambda_{\text{H}^+}^\infty \\ &= 40.9 + 349.8 = 390.7 \text{ ohm}^{-1} \text{cm}^2 \text{eq.}^{-1}\end{aligned}$$

(ii) Evaluation of degree of dissociation

At $C = 0.1 \text{ M}$ $\alpha = \frac{\lambda^c}{\lambda^\infty} = \frac{5.20}{390.7} = 0.013$ i.e. 1.3%

or $\alpha = 1.3\%$

At $C = 0.001 \text{ M}$ $\alpha = \frac{\lambda^c}{\lambda^\infty} = \frac{49.2}{390.7} = 0.125$ i.e. 12.5%

Ex.12 E of some oxidants are given as :

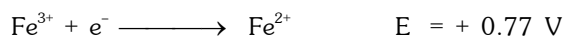
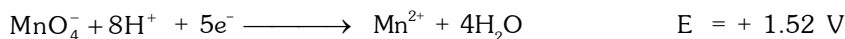

(a) Select the strongest reductant and oxidant in these.

(b) Select the weakest reductant and oxidant in these.

(c) Select the spontaneous reaction from the changes given below.

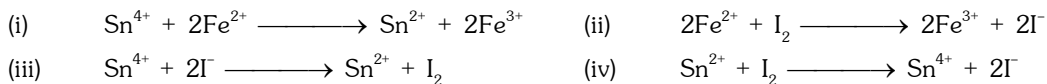

Sol. (a) More the E_{OP} , more is the tendency for oxidation. Therefore, since maximum E_{OP} stands for :



\therefore strongest reductant : **Sn^{2+}**
and weakest oxidant : **Sn^{4+}**

(b) More or +ve is E_{RP} , more is the tendency for reduction. Therefore, since maximum E_{RP} stands for :

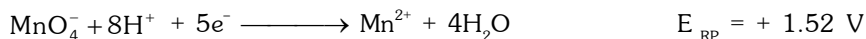

\therefore strongest oxidant : **MnO_4^-**
and weakest reductant : **Mn^{2+}**

Note : Stronger is oxidant, weaker is its conjugate reductant and vice-versa.

(c) For (i) $E_{\text{Cell}}^\circ = E_{\text{OP}_{\text{Fe}^{2+}/\text{Fe}^{3+}}}^\circ + E_{\text{RP}_{\text{Sn}^{4+}/\text{Sn}^{2+}}}^\circ = -0.77 + 0.1$

Fe^{2+} oxidizes and Sn^{4+} reduces in change.

$\therefore E_{\text{Cell}}^\circ = -0.67\text{V}$

E_{Cell}° is negative.

\therefore (i) **Is non-spontaneous change.**

For (ii) $E_{\text{Cell}}^\circ = E_{\text{OP}_{\text{Fe}^{2+}/\text{Fe}^{3+}}}^\circ + E_{\text{RP}_{\text{I}_2/\text{I}^-}}^\circ = -0.77 + 0.54 = -0.23\text{V}$

\therefore (ii) **Is non-spontaneous change.**

For (iii) $E_{\text{Cell}}^\circ = E_{\text{OP}_{\text{I}^-/\text{I}_2}}^\circ + E_{\text{RP}_{\text{Sn}^{4+}/\text{Sn}^{2+}}}^\circ = -0.54 + 0.1 = -0.44\text{V}$

\therefore (iii) **Is non-spontaneous change.**

For (iv) $E_{\text{Cell}}^\circ = E_{\text{OP}_{\text{Sn}^{2+}/\text{Sn}^{4+}}}^\circ + E_{\text{RP}_{\text{I}_2/\text{I}^-}}^\circ = -0.1 + 0.54 = +0.44\text{V}$

(iv) **Is spontaneous change.**

Ex. 13 Given the standard electrode potentials ;

$$\text{K}^+/\text{K} = -2.93\text{V}, \text{Ag}^+/\text{Ag} = 0.80\text{V}, \text{Hg}^{2+}/\text{Hg} = 0.79\text{V}, \text{Mg}^{2+}/\text{Mg} = -2.37\text{V}, \text{Cr}^{3+}/\text{Cr} = -0.74\text{V}.$$

Arrange these metals in their increasing order of reducing power.

Sol. More is E_{RP} , more is the tendency to get reduced or more is the oxidising power or lesser is reducing power.

$$\text{Ag} < \text{Hg} < \text{Cr} < \text{Mg} < \text{K}$$

Ex. 14 Answer of following :

(i) In a cell, anode is represented by -ve sign and cathode by +ve sign. What is the type of the cell?

(ii) Write the reaction taking place at anode in the following cell :



(iii) With the help of the following possible reactions, arrange Mg, Zn, Cu and Ag in decreasing order of their reduction potentials.

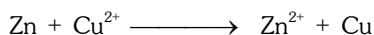
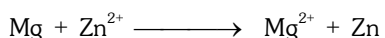
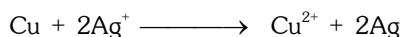

(iv) Cl_2 can displace I_2 from KI solution but I_2 does not displace.

(v) The E° (standard oxidation potentials) values of the elements A, B, C and D are + 0.76, - 0.34, + 0.25 and - 0.85 volt respectively. Arrange these in decreasing order of reactivity.

- Sol.** (i) The cell is an electrochemical cell i.e. galvanic cell.
(ii) Reaction taking place at anode is : $\text{H}_2 \longrightarrow 2\text{H}^+ + 2\text{e}^-$
(iii) The decreasing order of reduction potentials in : $\text{Ag} > \text{Cu} > \text{Zn} > \text{Mg}$
(iv) I^- is stronger reducing agents than Cl^- . Therefore, I^- can reduce Cl_2 to Cl^- ions whereas Cl^- cannot reduce I_2 to I^- . Thus, only the following reaction is feasible.

$$\text{Cl}_2 + 2\text{I}^- (2\text{KI}) \longrightarrow 2\text{KCl} (2\text{Cl}^-) + \text{I}_2$$

(v) The reactivity of an elements is directly porportional to its standard oxidation potential (E). The decreasing order of reactivity of elements is : $\text{A} > \text{C} > \text{B} > \text{D}$.

Ex.15 A cell is prepared by dipping a copper rod in 1 M CuSO_4 solution and a nickel rod in 1M NiSO_4 . The standard reduction potentials of copper and nickel electrodes are + 0.34 V and -0.25 V respectively.

- (i) Which electrode will work as anode and which as cathode ?
(ii) What will be the cell reaction ?
(iii) How is the cell represented ?
(iv) Calculate the EMF of the cell.

Sol. (i) The nickel electrode with smaller E value (-0.25 V) will work as anode while copper electrode with more E value (+0.34V) will work as cathode.

(ii) The cell reaction may be written as :

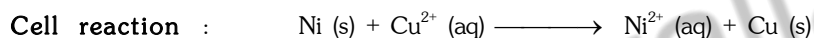
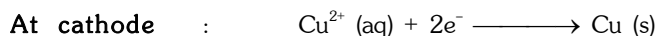
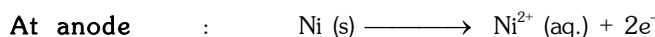

(iii) The cell may be represented as :



(iv) $\text{EMF of cell} = E_{\text{cathode}}^{\circ} - E_{\text{anode}}^{\circ} = (+0.34) - (-0.25) = 0.59 \text{ V}$

Ex.16 Predict whether the following reaction can occur under standard conditions or not.



Given $E_{\text{Sn}^{4+}/\text{Sn}^{2+}} = + 0.15$, $E_{\text{Br}_2/\text{Br}^-} = 1.06\text{V}$.

Sol. $E_{\text{cell}}^{\circ} = E_{\text{cathode}}^{\circ} - E_{\text{anode}}^{\circ} = 1.06 - 0.15 = 0.91\text{V}$.

Since, E_{cell}° comes out be positive, this means that the reaction can occur.

Ex.17 Given that, $\text{Co}^{3+} + \text{e}^- \longrightarrow \text{Co}^{2+}$ $E = + 1.82\text{V}$

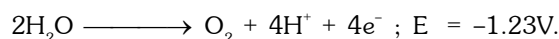

Explain why Co^{3+} is not stable in aqueous solutions.

Sol. The E_{cell}° can be calculated as follows :

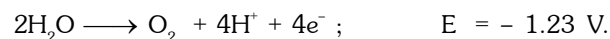
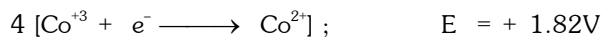

Add : $4\text{Co}^{3+} + 2\text{H}_2\text{O} \longrightarrow 4\text{Co}^{2+} + 4\text{H}^+ + \text{O}_2 ; E = 1.82 - 1.23 = + 0.59\text{V}$.

Since E_{cell}° is positive, the cell reaction is spontaneous. This means that Co^{3+} ions will take part in the reaction. Therefore, Co^{3+} is not stable.

Ex.18 The measured e.m.f. at 25 C for the cell reaction,

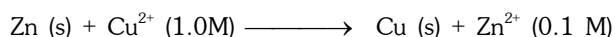

is 1.3 volt Calculate E for the cell reaction.

Sol. Using Nernst equation (at 298 K),

$$E_{\text{cell}} = E_{\text{cell}}^{\circ} - \frac{0.0591\text{V}}{2} \log \frac{[\text{Zn}^{2+}(\text{aq})]}{[\text{Cu}^{2+}(\text{aq})]}$$

Here $E_{\text{cell}} = 1.3\text{ V}$, $[\text{Cu}^{2+}(\text{aq})] = 1.0\text{ M}$, $[\text{Zn}^{2+}(\text{aq})] = 0.1\text{ M}$, $E_{\text{cell}}^{\circ} = ?$

Substituting the values,

$$1.3\text{ V} = E_{\text{cell}}^{\circ} - \frac{0.0591\text{V}}{2} \log \frac{0.1}{1.0}$$

$$1.3\text{ V} = E_{\text{cell}}^{\circ} - 0.02955\text{ V} \log 10^{-1}$$

$$1.3\text{ V} = E_{\text{cell}}^{\circ} + 0.02955\text{ V} \log 10$$

$$E_{\text{cell}}^{\circ} = 1.3\text{ V} - 0.02955\text{ V} = 1.27\text{ V}$$

Ex.19 Calculate ΔG for the reaction : $\text{Cu}^{2+}(\text{aq}) + \text{Fe}(\text{s}) \rightleftharpoons \text{Fe}^{2+}(\text{aq}) + \text{Cu}(\text{s})$. Given that $E_{\text{Cu}^{2+}/\text{Cu}} = +0.34\text{ V}$,

$$E_{\text{Fe}^{2+}/\text{Fe}}^{\circ} = -0.44\text{ V}$$

Sol. The cell reactions are :



We know that : $\Delta G^{\circ} = -nFE_{\text{cell}}^{\circ}$; $n = 2\text{ mol}$,

$$E_{\text{cell}}^{\circ} = \left[E_{\text{(Cu}^{2+}/\text{Cu)}}^{\circ} - E_{\text{(Fe}^{2+}/\text{Fe)}}^{\circ} \right]$$

$$= (+0.34\text{ V}) - (-0.44\text{ V}) = +0.78\text{ V}$$

$$F = 96500\text{ C mol}^{-1}$$

$$\therefore \Delta G^{\circ} = -nFE_{\text{cell}}^{\circ}$$

$$= -(2\text{mol}) (96500\text{ C mol}^{-1}) (+0.78\text{ V})$$

$$= -150540\text{ CV} = -150540\text{ J} \quad (\because 1\text{ CV} = 1\text{ J})$$

Ex.20 How will show that Faraday's second law of electrolysis is simply corollary of the first law.

Sol. According to Faraday's first law of electrolysis.

$$w = Z Q$$

If same quantity of electricity is passed through two electrolytes, i.e., $Q_1 = Q_2 = Q$, then

$$\text{In case of first electrolyte, } w_1 = Z_1 Q \quad \text{and}$$

$$\text{In case of second electrolyte, } w_2 = Z_2 Q$$

$$\text{On dividing , } \frac{w_1}{w_2} = \frac{Z_1}{Z_2} = \frac{E_1/96500}{E_2/96500} = \frac{E_1}{E_2}$$

where E_1 and E_2 are their equivalent masses.

Ex.21 Iron does not rust even if zinc coating on its surface is broken but the same is not true when coating is of tin.

Sol. The zinc is more reactive than iron. This means that if a crack appears on the surface of iron coated with zinc even then zinc will take part in the redox reaction and not iron. In other words, zinc will be corroded in preference to iron. But same is not in the case with tin. It is less reactive than iron. If a crack appears on the surface of iron coated with tin, then iron will take part in the redox reaction and not tin. Therefore, iron will be corroded under these circumstances.

Ex.22 A Solution of copper (II) sulphate is electrolysed between copper electrodes by a current of 10.0 amperes passing for one hour. What changes occur at the electrodes and in the solution ?

Sol. According to Faraday's first law of electrolysis :

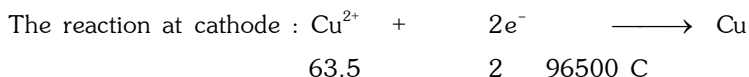

The quantity of charge passed = $I \times t = (10 \text{ amp}) (60 \times 60 \text{ s}) = 36000 \text{ C}$.

$\frac{63.5}{2} \times 96500 \text{ C}$ of charge deposit copper = 63.5 g

$$36000 \text{ C of charge deposit copper} = \frac{(63.5 \text{ g})}{(2 \times 96500 \text{ C})} \times (36000 \text{ C}) = 11.84 \text{ g}$$

Thus, 11.84 g of copper will dissolve from the anode and the same amount from the solution will get deposited on the cathode. The concentration of the solution will remain unchanged.

Ex.23 Calculate the equilibrium constant for the reaction at 298 K

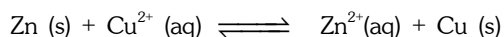

Given $E_{\text{Zn}^{2+}/\text{Zn}}^{\circ} = -0.76 \text{ V}$ and $E_{\text{Cu}^{2+}/\text{Cu}}^{\circ} = +0.34 \text{ V}$

Sol. We know that, $\log K_c = \frac{nE_{\text{cell}}^{\circ}}{0.0591}$

$$E_{\text{cell}}^{\circ} = [E_{\text{Cathode}}^{\circ} - E_{\text{Anode}}^{\circ}]$$

$$= [(+0.34 \text{ V}) - (-0.76 \text{ V})] = 1.10 \text{ V}, n = 2,$$

$$\therefore \log K_c = \frac{2 \times (1.10 \text{ V})}{(0.0591 \text{ V})} = 37.29$$

$$K_c = \text{Antilog } 37.29 = 1.95 \times 10^{37}$$

Ex.24 Calculate the cell e.m.f. and ΔG for the cell reaction at 298 K for the cell.

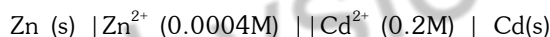

Given $E_{\text{Zn}^{2+}/\text{Zn}}^{\circ} = -0.763 \text{ V}$; $E_{\text{Cd}^{2+}/\text{Cd}}^{\circ} = -0.403 \text{ V}$ at 298 K.

$F = 96500 \text{ C mol}^{-1}$.

Sol. Step I. Calculation of cell e.m.f.

According to Nernst equation

$$E = E^{\circ} - \frac{0.0591}{n} \log \frac{[\text{Zn}^{2+} (\text{aq})]}{[\text{Cd}^{2+} (\text{aq})]}$$

$$E_{\text{cell}}^{\circ} = E_{(\text{Cd}^{2+}/\text{Cd})}^{\circ} - E_{(\text{Zn}^{2+}/\text{Zn})}^{\circ} = (-0.403) - (-0.763) = 0.36 \text{ V}$$

$[\text{Zn}^{2+} (\text{aq})] = 0.0004 \text{ M}$, $[\text{Cd}^{2+} (\text{aq})] = 0.2 \text{ M}$, $n = 2$

$$E = (0.36) - \frac{(0.0591 \text{ V})}{2} \log \frac{0.0004}{0.2}$$

$$= 0.36 - \frac{(0.0591 \text{ V})}{2} \times (-2.69990)$$

$$= 0.36 \text{ V} + 0.08 = 0.44 \text{ V}$$

Step II. Calculation of ΔG

$$\Delta G = -nFE_{\text{cell}}$$

$$E_{\text{cell}} = 0.44 \text{ V}, n = 2 \text{ mol}, F = 96500 \text{ C mol}^{-1}$$

$$\therefore \Delta G = - (2 \text{ mol}) (96500 \text{ C mol}^{-1}) (0.44 \text{ V})$$

$$= - 84920 \text{ CV} = - 84920 \text{ J}$$